



For further details on Atlanta Bathroom
Furniture contact your approved
dealer or telephone the Sales/Customer
Service Department.
T 0191 428 0444
F 0191 489 0620
Email: enquiries@atlantabathrooms.com

www.atlantabathrooms.com

All prices include V.A.T. at 20%
January 2012 E&OE



dream bathrooms

Atlanta



Atlanta bathroom furniture comprises an impressive range of stylish door finishes and cabinet colours that combine high quality with sensible prices.

It's a choice complemented with a wide selection of optional accessories and co-ordinating tops designed to complete the bathroom you've always wanted.

Meticulous attention to detail, with all cabinets produced to the same specification, ensures you enjoy attractive fitted bathroom furniture of tasteful proportions that makes the most practical use of space.

bathroom storage solutions

simple bathroom elegance



atlanta BATHROOMS

BATHROOM FURNITURE

Features & Benefits	06 07
Door Collection & Price Bands	08 09
Colourmix Combinations & Price Bands	10 11
Romano	12 13
Bianco	14 15
Odessa	16 17
Lucia	18 19
Verona	20 21
Sorrento	22 23
Modena	24 25
Sienna	26 27
Martella	28 29
Novara	30 31
Pescara	32 33
Sofia	34 35
Banbury	36 37
Torino	38 39
Milan	40 41
Collina	42 43
York	44 45
Castana	46 47
Vellino	48 49
Lucia	50 51
Novara	52 53

PRICE LIST

Standard 365mm	54
Washbasin Units	55 56
Toilet Units	57 58
Base Units	59 60
Tall Units	61
Slimline 250mm	62
Washbasin Units	63
Toilet Units	64 65
Base Units & Tall Unit	66 67
Wall Units & General Items	68
Mirrored Wall Units & Mirrors	69 71
Bath panels & Accessories	72 73
Sanitaryware	74 77
Brassware, Lighting & Accessories	78 79
Handles	80 81
Counter Tops & Shelving	82 83
Solid Surface Counter Tops	84 85
Corian Counter Tops	86 87
Dimensions and Price Examples	88 89
Quality & Guarantees	90 91

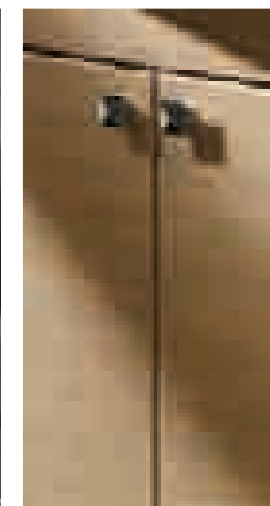
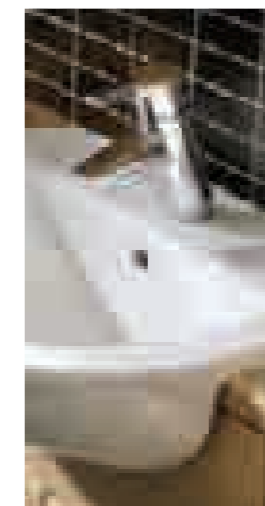

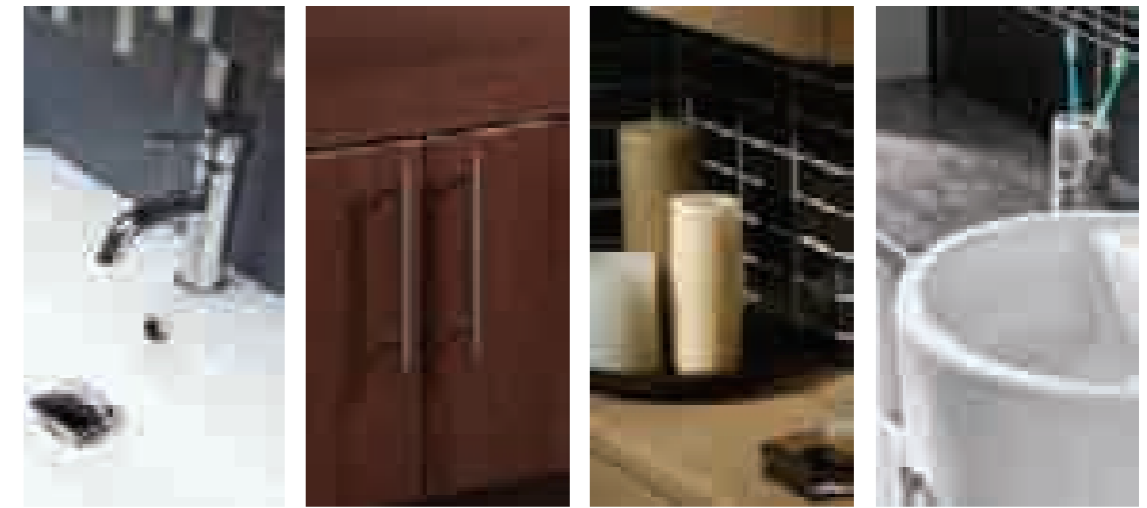

DOORS

Atlanta offers six door styles and thirteen door colours with integral soft close hinges, giving countless combinations.

BASE UNITS

A wide selection will enable you to create your individual look, with the option of matching or contrasting door and cabinet options, in all colours, for the ultimate bathroom interior.

WALL UNITS

Storage is at a premium in the bathroom so Atlanta offers an 800mm high wall cabinet with adjustable internal shelves to utilise every inch of storage space.

COUNTER TOPS

Atlanta can give matching or contrasting counter top options in laminate, Solid Surface and Corian.

SANITARYWARE

Enhance your bathroom by selecting one of the many ranges Atlanta offers. Both contemporary and ultra modern designs are offered to suit the style you desire.

BRASSWARE

To complement your sanitaryware choose our brassware which carries an extensive guarantee.

HANDLES

Careful consideration to your choice of handle can make all the difference. From small and delicate to the more bold statement, Atlanta has the handle for your own taste and application.

MIRRORS

Whether its classic or modern, plain or framed or even cabinets with double sided mirrored doors, we can offer you a host of sizes to suit your application and requirements.

LIGHTING

A comprehensive range of lights are on offer, please be sure to check the IP rating prior to installation.

dream solutions

atlantabathrooms.com

PRICE BAND 1 PRICE BAND 2



MILAN
PRICE BAND 1
Page 40-41
Door: Matt White
Cabinet: Matt White

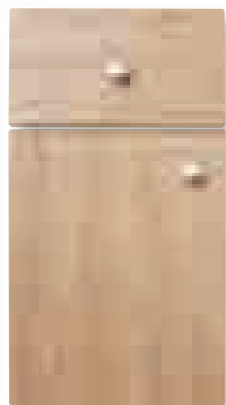

ODESSA
PRICE BAND 2
Page 16-17
Door: Odessa Oak Effect
Cabinet: Odessa Oak Effect



ROMANO
PRICE BAND 2
Page 12-13
Door: Cherry Effect
Cabinet: Cherry Effect

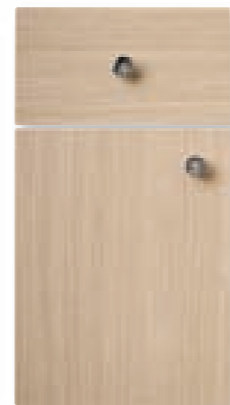

SORRENTO
PRICE BAND 2
Page 22-23
Door: Ferrara Oak Effect
Cabinet: Ferrara Oak Effect

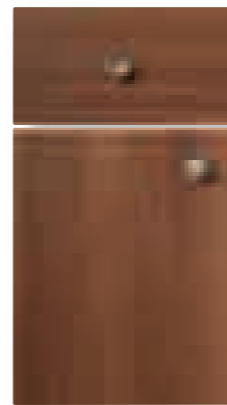

MARTELLA
PRICE BAND 2
Page 28-29
Door: Walnut Effect
Cabinet: Walnut Effect



YORK
PRICE BAND 2
Page 44-45
Door: Matt White
Cabinet: Matt White

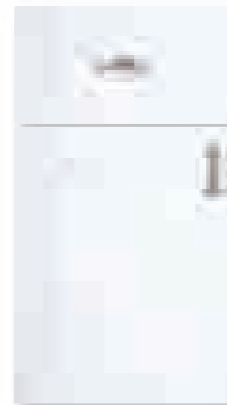

BANBURY
PRICE BAND 2
Page 36-37
Door: Matt White
Cabinet: Matt White

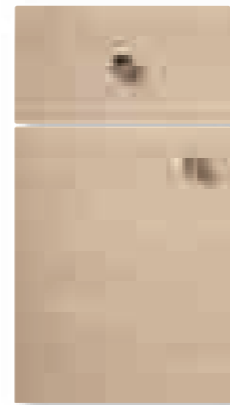

VELLINO
PRICE BAND 2
Page 48-49
Door: Ferrara Oak Effect
Cabinet: Ferrara Oak Effect

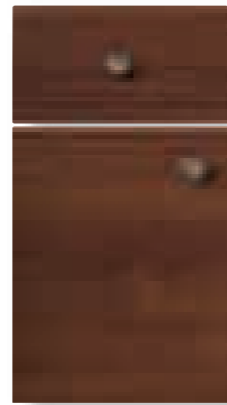

COLLINA
PRICE BAND 2
Page 42-43
Door: Walnut Effect
Cabinet: Walnut Effect

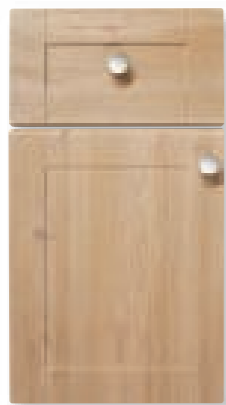

SOFIA
PRICE BAND 2
Page 34-35
Door: Odessa Oak Effect
Cabinet: Odessa Oak Effect

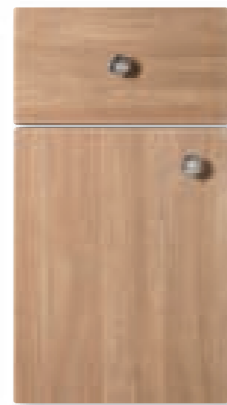

VERONA
PRICE BAND 2
Page 20-21
Door: Natural Walnut Effect
Cabinet: Natural Walnut Effect

PRICE BAND 3 PRICE BAND 4 PRICE BAND 5 PRICE BAND 6

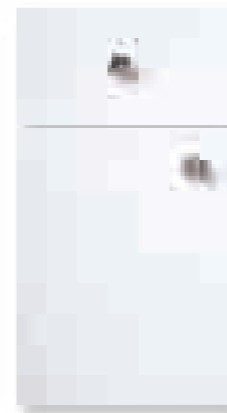

LUCIA
PRICE BAND 3
Page 18-19
Door: Gloss White
Cabinet: Matt White

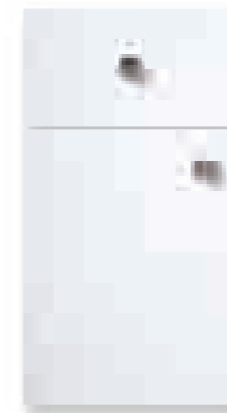

LUCIA PREMIUM
PRICE BAND 4
Page 18-19
Door: Gloss White
Cabinet: Gloss White Exterior



NOVARA
PRICE BAND 5
Page 30-31
Door: Anthracite Lustre
Cabinet: Timber Effect

Please refer to Colourmix



NOVARA PREMIUM
PRICE BAND 6
Page 52-53
Door: Anthracite Lustre
Cabinet: Gloss White Exterior



MODENA
PRICE BAND 3
Page 24-25
Door: Gloss White
Cabinet: Matt White

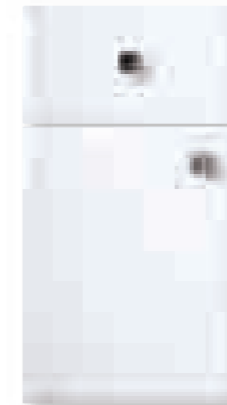

MODENA PREMIUM
PRICE BAND 4
Page 24-25
Door: Gloss White
Cabinet: Gloss White Exterior



SIENNA
PRICE BAND 3
Page 26-27
Door: Gloss Cherry
Cabinet: Cherry Effect

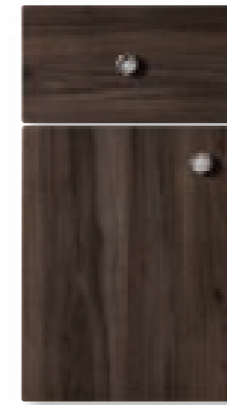

TORINO PREMIUM
PRICE BAND 4
Page 38-39
Door: Gloss Smoked Pearwood Effect
Cabinet: Gloss White Exterior



BIANCO PREMIUM
PRICE BAND 6
Page 14-15
Door: Gloss White
Cabinet: Gloss White Exterior

Atlanta offers six door styles and thirteen door colours giving countless combinations

Novara Price Band 6 Anthracite lustre door Gloss white exterior cabinet



colourmix combinations & price bands

COLOURMIX

The range of doors illustrated are available on our Colourmix cabinets. Choose from the ever popular Ferrara Oak, the warm mid tones of Natural Walnut, Odessa Oak and Romano Cherry to the striking rich hue of Walnut. Several stunning examples of Colourmix combinations are featured in the following pages to inspire you in your final selection.



odessa oak

ferrara oak

walnut

romano cherry

milan door

natural walnut

MILAN
Price Band 1
Page 40-41
Door: Matt White
Cabinet: Timber effect

BANBURY
Price Band 2
Page 36-37
Door: Matt White
Cabinet: Timber effect

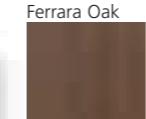
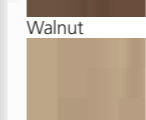
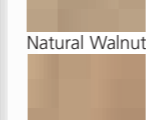
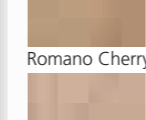

-  Ferrara Oak
-  Walnut
-  Natural Walnut
-  Romano Cherry
-  Odessa Oak

CASTANA
Price Band 3
Page 46-47
Door: Bisque Gloss
Cabinet: Timber effect

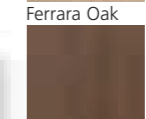
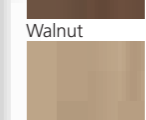
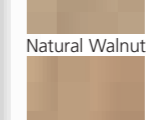
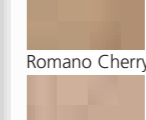

-  Ferrara Oak
-  Walnut
-  Natural Walnut
-  Romano Cherry
-  Odessa Oak

PESCARA
Price Band 3
Page 32-33
Door: Cream Gloss
Cabinet: Timber effect



-  Ferrara Oak
-  Walnut
-  Natural Walnut
-  Romano Cherry
-  Odessa Oak

LUCIA
Price Band 3
Page 50-51
Door: White Gloss
Cabinet: Timber effect

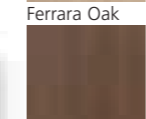
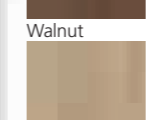
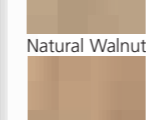
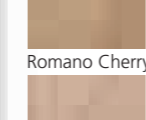

-  Ferrara Oak
-  Walnut
-  Natural Walnut
-  Romano Cherry
-  Odessa Oak

MODENA
Price Band 3
Page 24-25
Door: White Gloss
Cabinet: Timber effect

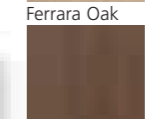
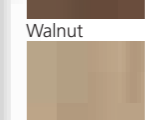
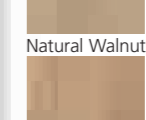
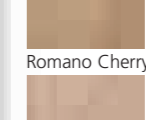

-  Ferrara Oak
-  Walnut
-  Natural Walnut
-  Romano Cherry
-  Odessa Oak

NOVARA
Price Band 5
Page 30-31
Door: Anthracite Lustre
Cabinet: Timber effect



-  Ferrara Oak
-  Walnut
-  Natural Walnut
-  Romano Cherry
-  Odessa Oak

romano

Romano is our latest evolution of a cherry effect finish. It has warm tones and increased colour variations within the design. We are sure that Romano will prove to be an exceptionally popular mid coloured woodgrain effect.

A future classic.

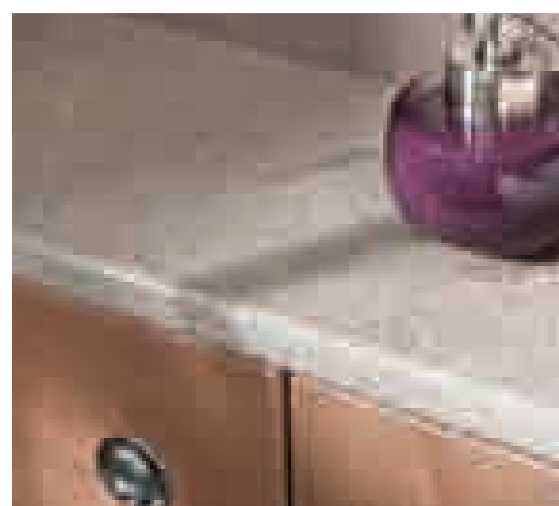
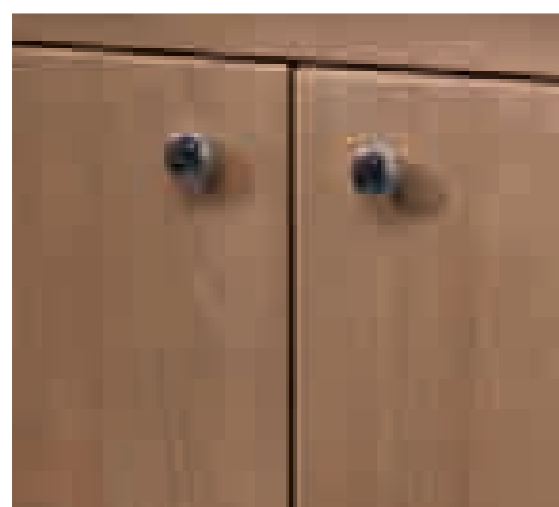

bianco

PREMIUM

Stunning white high gloss acrylic faced doors with dual tone impact resistant edging, sitting on Premium cabinets which are the height of luxury. This cool, sophisticated elegant range offers affordable style for today's fashion bathroom



atlantabathrooms.com

odessa

Odessa Oak with its highly tactile structure in a rich mid toned finish with matching cabinets. While being a traditional timber effect the neat slab doors, look equally at home in a classic or modern bathroom.

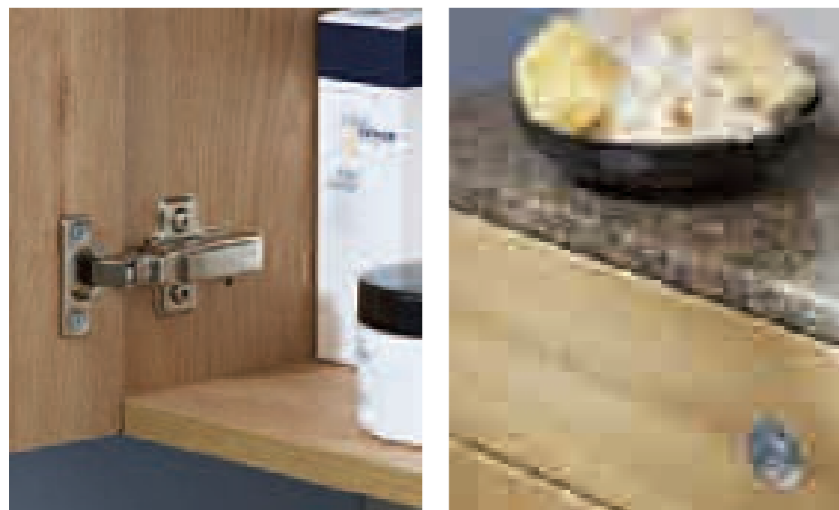

Lucia

Striking white gloss, elegantly smooth with subtle curves creates the classic sleek look of Lucia. Useful storage options coupled with stylish accessories produce a highly desirable bathroom.

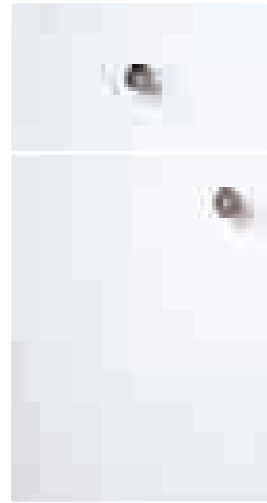
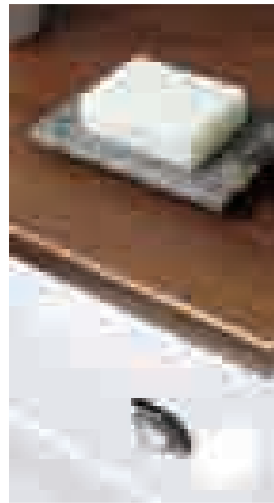

verona

Finished in a natural Walnut Effect combined with co-ordinated cabinets.
Verona gives a clean and efficient look for today's lifestyle.

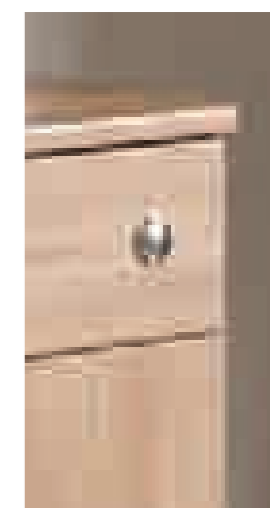
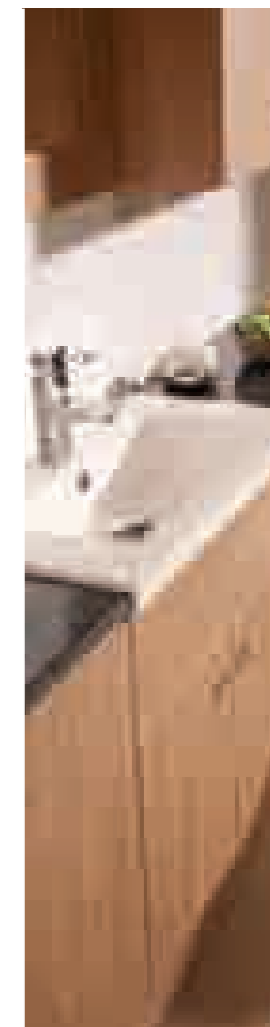



sorrento
SLIMLINE

Beautifully styled, practically proportioned and a luxurious finish, Slimline Sorrento in Ferrara Oak. Its simplicity and design should be applauded for its understated function, the elongated bar handles accentuate its subtle grain pattern.





modena

The uncompromising ultimate in bathroom brilliance truly beautiful Modena is a dream solution that will never date. Clever use of Solid Surface shelves and countertops enhance the dramatic look of this classic.





sienna

Sienna is a truly elegant gloss cherry woodgrain, sitting on subtle matt cherry Romano cabinets it offers bathroom furniture with warmth and complementary tones of strong reflecting gloss front panels.

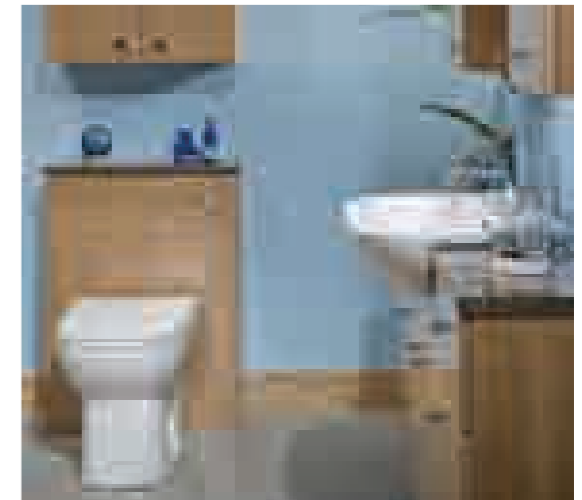



martella

Modern lines and smooth contours accentuate the harmony and simplicity of Martella, a minimalist bathroom that's anything but square.

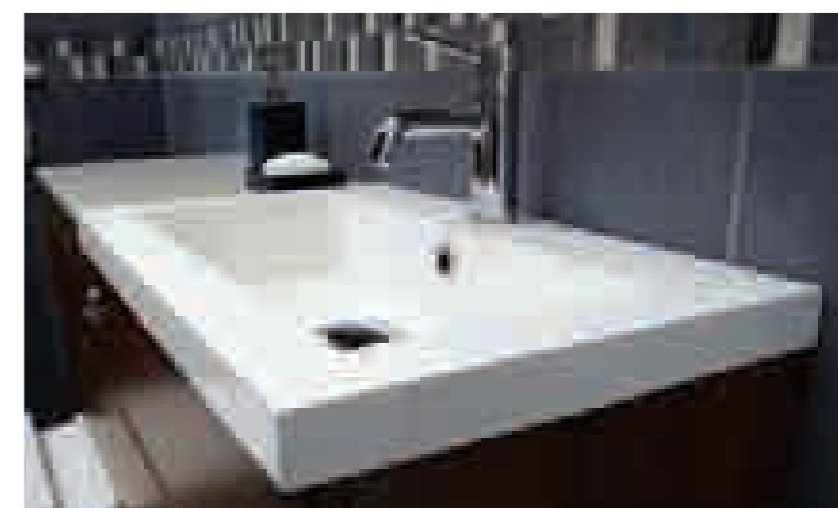



novara

Novara's new technology, it is high gloss acrylic panels with superb reflective properties, Novara is based on an anthracite tone and is a great match for any of the five cabinet choices offered.

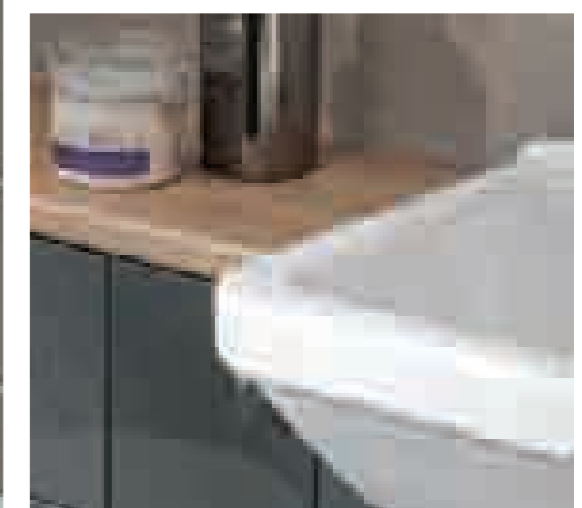
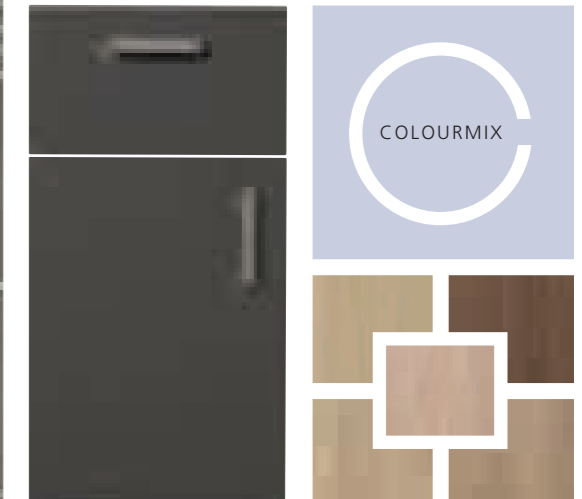

pescara

Pescara is a pale cream gloss a versatile colour but offering more subtlety than white. Available on a variety of woodgrain cabinets, Ferrara Oak, Romano Cherry, a dark rich Walnut or mid toned Natural Walnut, the choice is yours.





sofia

Matching versatility with artful expression, these beautiful "shaker" style doors in a stunning oak effect finish with co-ordinating cabinets create a welcome, homely, airy atmosphere.

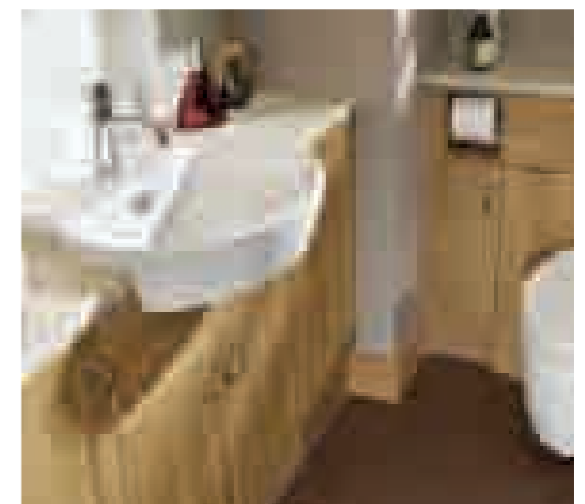
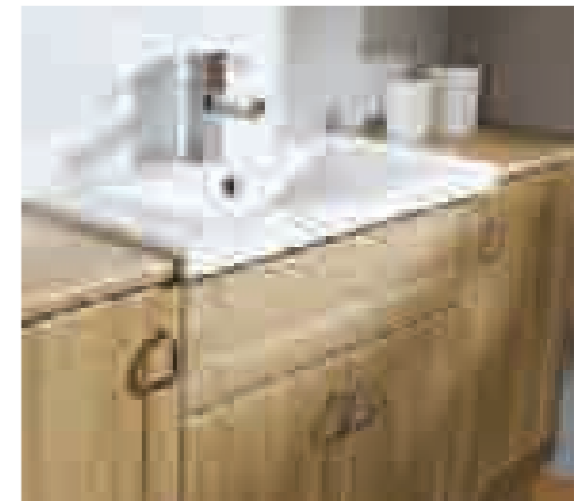
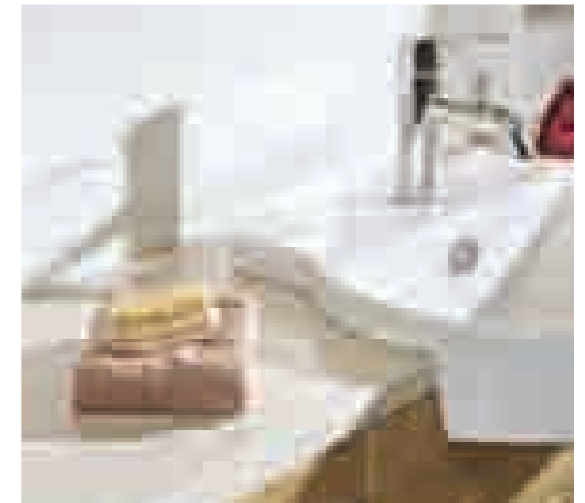

banbury

As part of the 'Colourmix' range,
Banbury sits perfectly
on the contrasting cabinetry,
creating a sense of contemporary
style and sophistication.





torino

PREMIUM

Hi-tec wood effect gloss contrasted with the white gloss Premium cabinet create this stunning bathroom. Bringing the Breeze basin and Solid Surface countertops together in total harmony.

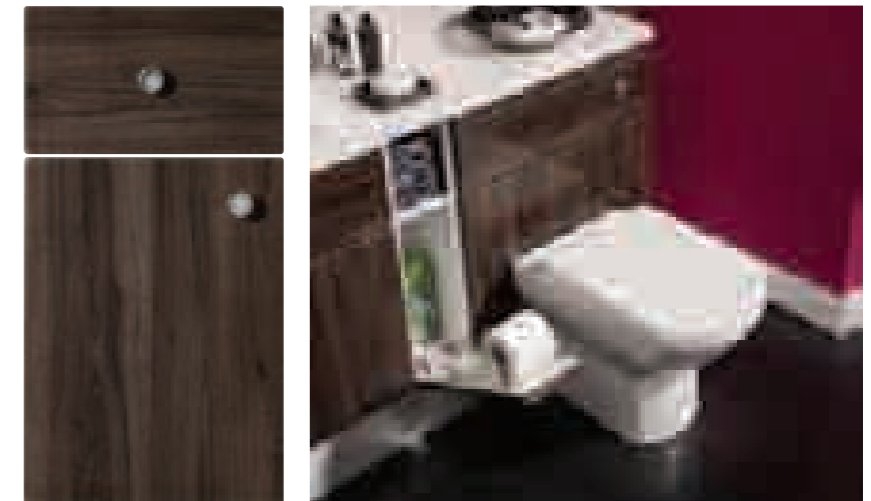

milan Sleek rectangular lines combine with soft curves to show Milan at it's very best.
The purity of finish is truly beautiful yet the bathroom remains both practical and simple.



sollina

The simple look is the hallmark of beauty.
Horizontal Grain patterns
enhance the striking Walnut colour
with stunning effect.



York

Sleek, clean and conventional,
York's traditional good looks
can nevertheless bring a contemporary
ambience to any environment.





castana

The subtle look of Bisque gloss Castana on Walnut cabinets accentuated with countertops and shelving.

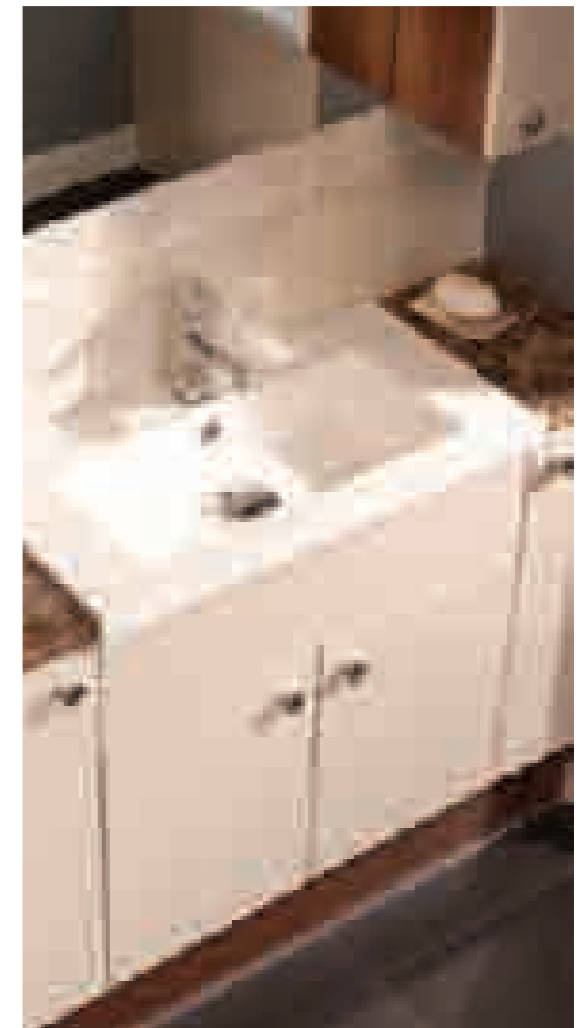
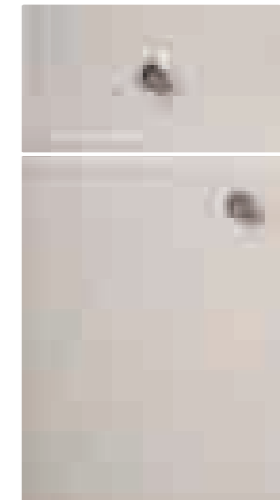

vellino

Inspired by linear lines Vellino is an exquisite design, the perfect fusion of form and function. Elegant curves of bold simplicity this modern suite is the ultra way to achieve the modern look that provides a softer statement.

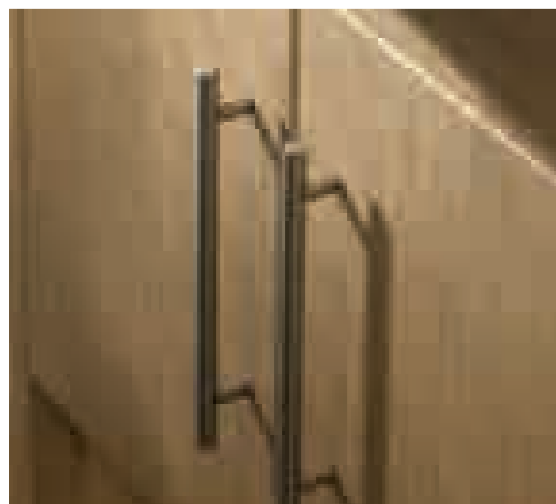

Lucia

The subtle curves blend with graceful contours to create the understated, sleek and practical range of Lucia White high gloss. These beautifully styled doors are available on both our Matt White, Premium and Colourmix cabinets



novara
SLIMLINE

Combining elegance with true space efficiency, these Novara doors on the Premium cabinet utilise the Slimline Breeze basin and matching WC.

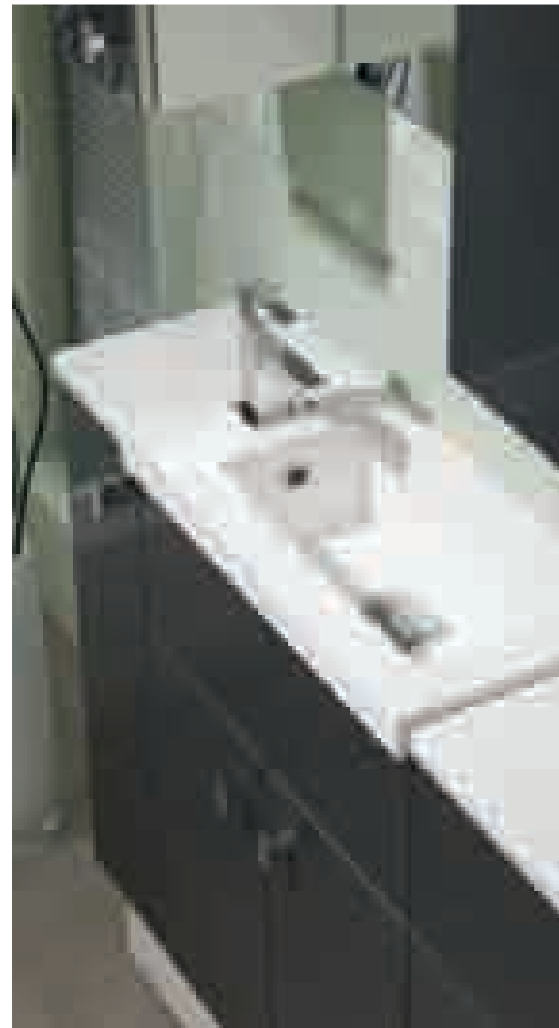

atlanta 365

The comprehensive and practical range of Atlanta base units are suitable for countertops with a depth of 365mm. The choice of cabinet designs offers storage solutions for bathrooms large and small and practical space saving ways to incorporate basins and toilets. The exciting array of cabinet styles includes furniture with doors or drawers, units to wall hang, full panel toilet units as well as a variety of tall storage units, all in a great range of finishes.

WASHBASIN UNITS INCLUDING BREEZE BASIN



UNIT DIMENSIONS: 375 D x 680 H overall including basin. (860 with legs).

WASHBASIN UNITS FOR SEMI-COUNTERTOP BASIN



UNIT DIMENSIONS: 360 D x 640 H overall excluding top. (820mm with legs).

WASHBASIN UNITS FOR CORIAN

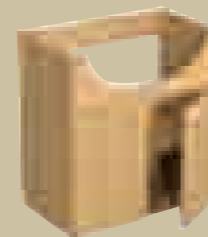

UNIT DIMENSIONS: 360 D x 640 H overall excluding top. (820mm with legs).

PRICE BAND	1	2	3	4	5	6
500mm R/50BBU - 510mm including basin	£531	£549	£591	£602	608	£619
600mm R/60BBU - 610mm including basin	£573	£593	£629	£642	£650	£663
700mm R/70BBU - 710mm including basin	£612	£635	£676	£690	£700	£714

Cabinets are dispatched fully assembled. Doors and top panel are packed separately. Supplied with four adjustable legs and one adjustable shelf matching the cabinet interior.

PRICE BAND	1	2	3	4	5	6
500mm R/50BCB	£201	£219	£261	£272	£278	£289
500mm R/50BCB/P plain top panel*		£219				
600mm R/60BCB	£233	£253	£289	£302	£310	£323
600mm R/60BCB/P plain top panel*		£253				
700mm R/70BCB	£262	£285	£325	£340	£350	£364
700mm R/70BCB/P plain top panel*		£285				

Cabinets are dispatched fully assembled. Doors and top panel are packed separately. Supplied with four adjustable legs and one adjustable shelf matching the cabinet interior.

*Plain panels offer an alternative to the routed panel standard on the Banbury, Sofia and York styles.

PRICE BAND	1	2	3	4	5	6
600mm R/60BCB/C	£233	£253	£289	£302		
700mm R/70BCB/C	£262	£285	£326	£340		

Cabinets are dispatched fully assembled. Doors and top panel are packed separately. Supplied with four adjustable legs and one adjustable shelf matching the cabinet interior.

Unit prices do not include tops, handles, plinths or sanitaryware unless otherwise stated. Sizes shown are overall dimensions in mm excluding tops. All prices include VAT.

SUSPENDED WASHBASIN UNITS
WALL MOUNTED INCLUDING BREEZE 610 BASIN



UNIT DIMENSIONS:
610 W x 375 D x 534 H
overall including basin.

PRICE BAND	1	2	3	4	5	6
600mm R/S60BBU*	£544	£564	£564	£573	£579	£588
600mm R/S60BBDU*	£557	£577	£603	£613	£613	£623

Cabinets are dispatched fully assembled. Doors and top panel are packed separately.

* Excluding Banbury, Sofia and York.

SUSPENDED WASHBASIN UNITS
WALL MOUNTED FOR SEMI-COUNTERTOP BASIN

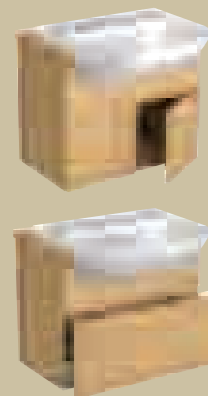

UNIT DIMENSIONS:
600 W x 360 D x 494 H
overall excluding top.

PRICE BAND	1	2	3	4	5	6
600mm R/S60BCB*	£204	£224	£224	£233	£239	£248
600mm R/S60BCBD*	£217	£237	£263	£273	£273	£283

Cabinets are dispatched fully assembled. Doors and top panel are packed separately.

* Excluding Banbury, Sofia and York.

SUSPENDED WASHBASIN UNITS
WALL MOUNTED FOR CORIAN®



UNIT DIMENSIONS:
600 W x 360 D x 494 H
overall excluding top.

PRICE BAND	1	2	3	4	5	6
600mm R/S60BCB/C*	£204	£224	£224	£233		
600mm R/S60BCBD/C*	£217	£237	£263	£273		

Top panel pre-cut to accept Corian cowl. Cabinets are dispatched fully assembled. Doors and top panels are packed separately.

* Excluding Banbury, Sofia and York.

Unit prices do not include tops, handles, plinths or sanitaryware unless otherwise stated. Sizes shown are overall dimensions in mm excluding tops. All prices include VAT.

TOILET UNITS
FULL PANEL DESIGN FOR "BACK TO WALL" AND SUSPENDED TOILETS



UNIT DIMENSIONS:
360 D x 820 H
overall excluding top.

PLINTHLINE TOILET UNITS
FOR USE WITH CONTINUOUS PLINTH FOR "BACK TO WALL" TOILETS



UNIT DIMENSIONS:
360 D x 820 H
overall excluding top.

PRICE BAND	1	2	3	4	5	6
500mm RC/FP50WC	£337	£353	£389	£404	£401	£417
600mm RC/FP60WC	£353	£370	£404	£420	£422	£438
600mm RC/FP60WC/P plain top panel*		£370				
700mm RC/FP70WC	£370	£387	£421	£437	£443	£460
700mm RC/FP70WC/P plain top panel*		£387				
SUSPENSION FRAME SFKW/C	£145	£145	£145	£145	£145	£145

Cabinets are dispatched fully assembled and supplied with a dual flush cistern. Top and lower panels are packed separately. These units are compatible with floorstanding 'back to wall' toilets or suspended toilets when used with a suitable suspension frame. Use SFKW/C code for frame. 500mm wide toilet units are supplied with a plain top panel.

*Plain panels offer an alternative to the routed panel standard on the Banbury, Sofia and York styles.

PRICE BAND	1	2	3	4	5	6
500mm RC/50BCC	£337	£353	£389	£404		
600mm RC/60BCC	£353	£370	£404	£420		
600mm RC/60BCC/P plain top panel*		£370				
700mm RC/70BCC	£370	£387	£421	£437		
700mm RC/70BCC/P plain top panel*		£387				

Cabinets are dispatched fully assembled and supplied with a dual flush cistern. Top and lower panels are packed separately. These units are compatible with floorstanding 'back to wall' toilets. 500mm wide toilet units are supplied with a plain top panel as standard.

*Plain panels offer an alternative to the routed panel standard on the Banbury, Sofia and York styles.

Unit prices do not include tops, handles, plinths or sanitaryware unless otherwise stated. Sizes shown are overall dimensions in mm excluding tops. All prices include VAT.

TOILET UNITS
FULL PANEL DESIGN
FOR "BACK TO WALL" AND
SUSPENDED TOILETS



UNIT DIMENSIONS:
360 D x 820 H
overall excluding top.

PRICE BAND	1	2	3	4	5	6
500mm R/FP50WC	£207	£223	£259	£274	£271	£287
600mm R/FP60WC	£223	£240	£274	£290	£292	£308
600mm R/FP60WC/P plain top panel*		£240				
700mm R/FP70WC	£240	£257	£291	£307	£313	£330
700mm R/FP70WC/P plain top panel*		£257				
SUSPENSION FRAME SFKW/C	£145	£145	£145	£145	£145	£145

Cabinets are dispatched fully assembled and supplied without a dual flush cistern. Top and lower panels are packed separately. These units are compatible with floorstanding 'back to wall' toilets or suspended toilets when used with a suitable suspension frame. Use SFKW/C code for frame. 500mm wide toilet units are supplied with a plain top panel.

*Plain panels offer an alternative to the routed panel standard on the Banbury, Sofia and York styles.

PLINTHLINE TOILET UNITS
FOR USE WITH CONTINUOUS
PLINTH FOR "BACK TO WALL"
TOILETS



UNIT DIMENSIONS:
360 D x 820 H
overall excluding top.

PRICE BAND	1	2	3	4	5	6
500mm R/50BCC	£207	£223	£259	£274		
600mm R/60BCC	£223	£240	£274	£290		
600mm R/60BCC/P plain top panel*		£240				
700mm R/70BCC	£240	£257	£291	£307		
700mm R/70BCC/P plain top panel*		£129				

Cabinets are dispatched fully assembled and supplied without a dual flush cistern. Top and lower panels are packed separately. These units are compatible with floorstanding 'back to wall' toilets. 500mm wide toilet units are supplied with a plain top panel as standard.

*Plain panels offer an alternative to the routed panel standard on the Banbury, Sofia and York styles.

**DUAL FLUSH
CISTERN OPTIONS**

PRICE BAND	1	2	3	4	5	6
CABLE OPERATED DFC/C	£130	£130	£130	£130	£130	£130
PNEUMATIC OPERATED DFC/P	£130	£130	£130	£130	£130	£130

Unit prices do not include tops, handles, plinths or sanitaryware unless otherwise stated. Sizes shown are overall dimensions in mm excluding tops. All prices include VAT.

BASE UNITS



UNIT DIMENSIONS:
360 D x 640 H
overall excluding top.
(820mm with legs)

PRICE BAND	1	2	3	4	5	6
175mm R/175BSD	£145	£152	£165	£178	£172	£184
350mm R/35BSD	£149	£159	£181	£193	£189	£202
700mm R/70B2SD - Double Door	£231	£251	£294	£307	£311	£324

Cabinets are dispatched fully assembled. Doors are supplied separately. Packed with four adjustable legs and an adjustable shelf or shelves as required matching the cabinet interior.

**175 TOILET ROLL
BASE UNIT**



UNIT DIMENSIONS:
245 D x 640 H

PRICE BAND	1	2	3	4	5	6
175mm 2R/175TRB 245mm deep	£170	£176	£187	£200	£190	£203

Cabinets are dispatched fully assembled. Door supplied separately. Packed with four adjustable legs. Not recommended on an end of run of 365mm deep furniture due to the depth of unit.

**350 PULL - OUT LINEN
BASE UNIT**



UNIT DIMENSIONS:
360 D x 640 H

PRICE BAND	1	2	3	4	5	6
350mm R/35PBSD	£212	£221	£243	£255	£252	£264

Includes linen basket. Suitable for small items of clothing. Cabinets are dispatched fully assembled. Doors are supplied separately. Packed with four adjustable legs.

**350 DRAWERLINE
BASE UNIT**

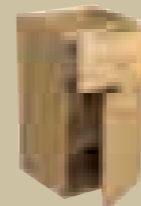

UNIT DIMENSIONS:
360 D x 640 H

PRICE BAND	1	2	3	4	5	6
350mm R/35BDD	£201	£221	£234	£247	£247	£260

Cabinets are dispatched fully assembled. Doors and drawers are supplied separately. Packed with four adjustable legs and an adjustable shelf or shelves as required matching the cabinet interior.

Unit prices do not include tops, handles, plinths or sanitaryware unless otherwise stated. Sizes shown are overall dimensions in mm excluding tops. All prices include VAT.

350 THREE DRAWER BASE UNIT



UNIT DIMENSIONS:
360 D x 640 H
overall excluding top.
(820mm with legs)

PRICE BAND	1	2	3	4	5	6
350mm R/35B3D	£276	£306	£292	£304	£307	£320

Cabinets are dispatched fully assembled. Drawers are supplied separately. Packed with four adjustable legs.

350 OPEN BASE UNITS

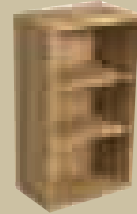

340mm UNIT DIMENSIONS:
340 D x 640 H overall excluding top.
(820mm with legs)

225mm UNIT DIMENSIONS:
225 D x 640 H overall excluding top.
(820mm with legs)

PRICE BAND	1	2	3	4	5	6
350mm R/OS 340mm deep to special order	£99	£99	£99	£99*	£99	£99*
350mm 2R/OS 225mm deep to special order	£89	£89	£89	£89*	£89	£89*

Cut to size service. Order between 150mm to 350mm wide. State finished size on ordering. This unit should not be placed on exposed ends as fixings are visible.

*This unit will be supplied in a Matt white finish, Gloss finish not available.

DOOR INFILL PANELS



Supplied as door finish with backboard suitable for base installation 640 H up to 175 W.

PRICE BAND	1	2	3	4	5	6
175mm DF D20 Door Infill Panel	£47	£52	£57	£57	£61	£61

Supplied as door finish with backboard. Suitable for base installation 640 H up to 175 W.



Variable corner post
Minimum size
55mm x 55mm.

Maximum size
55mm x 140mm.

Supplied as door finish 640 H.

PRICE BAND	1	2	3	4	5	6
VCP D32 Void Corner Post	£61	£65	£65	£65	£68	£68

Variable corner post, minimum size. 55mm x 55mm. Maximum size 55mm x 140mm. Supplied as door finish 640 H.

Unit prices do not include tops, handles, plinths or sanitaryware unless otherwise stated. Sizes shown are overall dimensions in mm excluding tops. All prices include VAT.

TALL BASE UNIT



UNIT DIMENSIONS:
350 W x 360 D x 1792 H
overall
(1972mm with legs)

PRICE BAND	1	2	3	4	5	6
350mm 35BTSD Tall Base Unit	£353	£378	£439	£460	£455	£475

Tall storage units are dispatched flat pack for home assembly. Door packs are supplied separately. Supplied with adjustable legs and three adjustable shelves matching the cabinet interior.

TALL DRAWLINE BASE UNIT



UNIT DIMENSIONS:
350 W x 360 D x 1792 H
overall
(1972mm with legs)

PRICE BAND	1	2	3	4	5	6
350mm 35BTDD Tall Drawline Base Unit	£405	£440	£493	£513	£512	£533

Tall storage units are dispatched flat pack for home assembly. Doors and drawer packs are supplied separately. Supplied with adjustable legs and three adjustable shelves matching the cabinet interior.

TALL OPEN BASE UNIT



UNIT DIMENSIONS:
350 W x 360 D x 1792 H
overall
(1972mm with legs)

PRICE BAND	1	2	3	4	5	6
350mm 35BTOSD Tall Open Base Unit	£324	£343	£387	£407	£404	£424

Tall storage units are dispatched flat pack for home assembly. Door packs are supplied separately. Supplied with adjustable legs and three adjustable shelves matching the cabinet interior.

TALL DRAWLINE OPEN BASE UNIT



UNIT DIMENSIONS:
350 W x 360 D x 1792 H
overall
(1972mm with legs)

PRICE BAND	1	2	3	4	5	6
350mm 35BTODD Tall Drawline Open Base Unit	£376	£405	£440	£461	£462	£482

Tall storage units are dispatched flat pack for home assembly. Doors and drawer packs are supplied separately. Supplied with adjustable legs and three adjustable shelves matching the cabinet interior.

Unit prices do not include tops, handles, plinths or sanitaryware unless otherwise stated. Sizes shown are overall dimensions in mm excluding tops. All prices include VAT.

atlanta 250

The problem of providing storage facilities in confined areas has been cleverly alleviated with inspirational designs in our Slimline range.

Combining elegance with true space efficiency, Atlanta's short projection basins including the compact Breeze basin give unequalled solutions.

SUSPENDED WASHBASIN UNITS
WALL MOUNTED FOR SEMI-COUNTERTOP BASIN



UNIT DIMENSIONS:
600 W x 245 D x 494 H
overall excluding top.

PRICE BAND	1	2	3	4	5	6
600mm 2R/560BCB*	£204	£224	£224	£233	£239	£248

Cabinets are dispatched fully assembled. Doors and top panel are packed separately.
*Excludes Banbury, Sofia and York.

WASHBASIN UNITS FOR SEMI-COUNTERTOP BASIN



UNIT DIMENSIONS:
245 D x 640 H
overall excluding top.
(820mm with legs)

PRICE BAND	1	2	3	4	5	6
500mm 2R/50BCB	£201	£219	£261	£272	£278	£289
500mm 2R/50BCB/P plain top panel*		£219				
600mm 2R/60BCB	£233	£253	£289	£302	£310	£323
600mm 2R/60BCB/P plain top panel*		£253				
700mm 2R/70BCB	£262	£285	£326	£340	£350	£364
700mm 2R/70BCB/P plain top panel*		£285				

Cabinets are dispatched fully assembled. Doors and top panels are packed separately. Supplied with four adjustable legs and one adjustable shelf matching the cabinet interior.

*Plain panels offer an alternative to the routed panel standard on the Banbury, Sofia and York.

WASHBASIN UNIT INCLUDING SLIMLINE 510 BREEZE BASIN



UNIT DIMENSIONS:
510 W x 260 D x 680 H
overall including basin.
(820mm with legs)

PRICE BAND	1	2	3	4	5	6
500mm 2R/50BBU	£481	£499	£541	£552	£558	£569

Cabinets are dispatched fully assembled. Doors and top panels are packed separately. Supplied with four adjustable legs and one adjustable shelf matching the cabinet interior.

Unit prices do not include tops, handles, plinths or sanitaryware unless otherwise stated. Sizes shown are overall dimensions in mm excluding tops. All prices include VAT.

TOILET UNITS
FULL PANEL DESIGN
FOR 'BACK TO WALL' AND
SUSPENDED TOILETS



UNIT DIMENSIONS:
245 D x 820 H
overall excluding top.

PRICE BAND	1	2	3	4	5	6
500mm 2RC/FP50WC	£337	£353	£389	£404	£401	£417
600mm 2RC/FP60WC	£353	£370	£404	£420	£422	£438
600mm 2RC/FP60WC/P plain top panel*		£370				
700mm 2RC/FP70WC	£370	£387	£421	£437	£443	£460
700mm 2RC/FP70WC/P plain top panel*		£387				
SUSPENSION FRAME SFKW/C	£145	£145	£145	£145	£145	£145

Cabinets are dispatched fully assembled and supplied with a dual flush cistern. Top and lower panels are packed separately. These units are compatible with floorstanding 'back to wall' toilets or suspended toilets when used with a suitable suspension frame. Use SFKW/C code for frame. 500mm wide toilet units are supplied with a plain top panel.

*Plain panels offer an alternative to the routed panel standard on the Banbury, Sofia and York styles.

PLINTHLINE TOILET UNITS
FOR USE WITH
CONTINUOUS PLINTH FOR
'BACK TO WALL' TOILETS



UNIT DIMENSIONS:
245 D x 820 H
overall excluding top.

PRICE BAND	1	2	3	4	5	6
500mm 2RC/50BCC	£337	£353	£389	£404		
600mm 2RC/60BCC	£353	£370	£404	£420		
600mm 2RC/60BCC/P plain top panel*		£370				
700mm 2RC/70BCC	£370	£387	£421	£437		
700mm 2RC/70BCC/P plain top panel*		£387				

Cabinets are dispatched fully assembled and supplied with dual flush cistern. Top and lower panels are packed separately. These units are compatible with floorstanding 'back to wall' toilets. 500mm wide toilet units are supplied with a plain top panel as standard.

*Plain panels offer an alternative to the routed panel standard on the Banbury, Sofia and York styles.

TOILET UNITS
FULL PANEL DESIGN
FOR 'BACK TO WALL' AND
SUSPENDED TOILETS



UNIT DIMENSIONS:
245 D x 820 H
overall excluding top.

PRICE BAND	1	2	3	4	5	6
500mm 2R/FP50WC	£207	£223	£259	£274	£271	£287
600mm 2R/FP60WC	£223	£240	£274	£290	£292	£308
600mm 2R/FP60WC/P plain top panel*		£240				
700mm 2R/FP70WC	£240	£257	£291	£307	£313	£330
700mm 2R/FP70WC/P plain top panel*		£257				
SUSPENSION FRAME SFKW/C	£145	£145	£145	£145	£145	£145

Cabinets are dispatched fully assembled and supplied without a dual flush cistern. Top and lower panels are packed separately. These units are compatible with floorstanding 'back to wall' toilets or suspended toilets when used with a suitable suspension frame. Use SFKW/C code for frame. 500mm wide toilet units are supplied with a plain top panel.

*Plain panels offer an alternative to the routed panel standard on the Banbury, Sofia and York styles.

PLINTHLINE TOILET UNITS
FOR USE WITH
CONTINUOUS PLINTH FOR
'BACK TO WALL'
TOILETS



UNIT DIMENSIONS:
245 D x 820 H
overall excluding top.

PRICE BAND	1	2	3	4	5	6
500mm 2R/50BCC	£207	£223	£259	£274		
600mm 2R/60BCC	£223	£240	£274	£290		
600mm 2R/60BCC/P plain top panel*		£240				
700mm 2R/70BCC	£240	£257	£291	£307		
700mm 2R/70BCC/P plain top panel*		£257				

Cabinets are dispatched fully assembled and supplied without a cistern. Top and lower panels are packed separately. These units are compatible with floorstanding 'back to wall' toilets. 500mm wide toilet units are supplied with a plain top panel as standard.

*Plain panels offer an alternative to the routed panel standard on the Banbury, Sofia and York styles.

**DUAL FLUSH CISTERN
OPTIONS**

PRICE BAND	1	2	3	4	5	6
CABLE OPERATED DFC/C	£130	£130	£130	£130	£130	£130
PNEUMATIC OPERATED DFC/P	£130	£130	£130	£130	£130	£130

SLIMLINE BASE UNITS



UNIT DIMENSIONS:
245 D x 640 H OVERALL
EXCLUDING TOP
(820mm WITH LEGS)

PRICE BAND	1	2	3	4	5	6
175mm 2R/175BSD	£145	£152	£165	£178	£172	£184
350mm 2R/35BSD	£149	£159	£181	£193	£189	£202

Cabinets are dispatched fully assembled. Doors are supplied separately.
Packed with four adjustable legs and an adjustable shelf matching the cabinet interior.

175 TOILET ROLL
BASE UNIT



UNIT DIMENSIONS:
245 D x 640 H OVERALL
EXCLUDING TOP
(820mm WITH LEGS)

PRICE BAND	1	2	3	4	5	6
175mm 2R/175TRB	£170	£176	£187	£200	£190	£203

Cabinets are dispatched fully assembled. Door supplied separately. Packed with four adjustable legs.
Not recommended on an end of run of 365mm deep furniture due to depth of unit.

350 OPEN BASE
UNIT - 225mm DEEP



UNIT DIMENSIONS:
225 D x 640 H OVERALL
EXCLUDING TOP
(820mm WITH LEGS)

PRICE BAND	1	2	3	4	5	6
350mm 2R/OS To special order	£89	£89	£89	£89*	£89	£89*

Cut to size service. Order between 150mm to 350mm wide. State finished size on ordering.
This unit should not be placed on ends as exposed fixings are visible.

*This unit will be supplied in a Matt white finish, Gloss finish not available.

Unit prices do not include tops, handles, plinths or sanitaryware unless otherwise stated. Sizes shown are overall dimensions in mm excluding tops. All prices include VAT.

DOOR INFILL PANEL



Supplied as door finish with backboard suitable for base installation 640 H up to 175 W.

PRICE BAND	1	2	3	4	5	6
175mm DF D20 Door infill panel	£47	£52	£57	£57	£61	£61

Supplied as door finish with backboard. Suitable for base installation 640 H up to 175 W.

VOID CORNER POST



Minimum size 55mm x 55mm.
Maximum size 55mm x 140mm.
Supplied as door finish 640 H.

PRICE BAND	1	2	3	4	5	6
VCP D32 Void corner post	£61	£65	£65	£65	£68	£68

Variable corner post, minimum size. 55mm x 55mm. Maximum size 55mm x 140mm.
Supplied as door finish 640 H.

TALL STORAGE UNIT
FOR 250mm DEPTH
(HOME ASSEMBLY)



UNIT DIMENSIONS:
350 W X 245 D
X 1792 H
OVERALL
(1972 mm
WITH LEGS)

PRICE BAND	1	2	3	4	5	6
350mm 2/35BTSD Tall base Unit	£353	£378	£439	£460	£455	£475

Tall storage units are dispatched flat pack for home assembly. Door packs are supplied separately.
Supplied with adjustable legs and three adjustable shelves matching the cabinet interior.

Unit prices do not include tops, handles, plinths or sanitaryware unless otherwise stated. Sizes shown are overall dimensions in mm excluding tops. All prices include VAT.

atlanta

Wall Units Mirror Wall Units Mirrors Shelf Units Bath Panels Accessories

Complement base units with the practical and stylish choice of wall cabinets, available with matching or mirrored doors. Plus shelf units or plain, framed and illuminated mirrors. Matching front and end panels can bring the bath into the picture also. Plus there are accessories galore, including countertops, sanitaryware, taps, handles and lighting. The choice is yours.

WALL UNITS

WALL UNITS 220 DEPTH



UNIT DIMENSIONS:
220 D x 800 H

MIRRORED WALL UNITS 220 DEPTH. DOORS MIRRORED ON BOTH SIDES



UNIT DIMENSIONS:
220 D x 800 H

SLIMLINE MIRRORED WALL UNITS 150 DEPTH. DOORS MIRRORED ON BOTH SIDES



UNIT DIMENSIONS:
150 D x 800 H

PRICE BAND	1	2	3	4	5	6
175mm R/175TW	£133	£141	£155	£165	£159	£169
350mm R/35TW	£158	£169	£201	£211	£208	£218
500mm R/50TW - Double Door	£219	£237	£278	£289	£283	£293
600mm R/60TW - Double Door	£232	£253	£306	£317	£316	£327
700mm R/70TW - Double Door	£246	£269	£332	£342	£346	£357

Cabinets are dispatched fully assembled with doors packed separately. Supplied with two adjustable shelves matching the cabinet interior.

PRICE BAND	1	2	3	4	5	6
175mm R/175TWM	£198	£198	£198	£207	£198	£207
350mm R/35TWM	£232	£232	£232	£242	£232	£242
600mm R/60TWM	£375	£375	£375	£387	£375	£387
700mm R/70TWM	£385	£385	£385	£395	£385	£395

Cabinets are dispatched fully assembled. Doors packed separately including H29 handles. Supplied with two adjustable shelves matching cabinet interior.

PRICE BAND	1	2	3	4	5	6
600mm R/60TWM/SL	£375	£375	£375	£387	£375	£387
700mm R/70TWM/SL	£385	£385	£385	£395	£385	£395

Cabinets are dispatched fully assembled. Doors packed separately including H29 handles. Supplied with two adjustable shelves matching cabinet interior.

600 FRAMED MIRROR

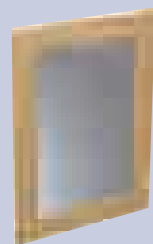

UNIT DIMENSIONS:
600 W x 18 D x 800 H

PRICE BAND	1	2	3	4	5	6
600mm 60TFM White	£130	£130				
600mm 60TFM Timber	£145	£145	£145		£145	
600mm 60TFM White Gloss			£210	£210		£210

The above framed mirrors have been carefully selected to co-ordinate with the cabinet finish. Please note that although the cabinets for Lucia, Modena and Sienna in Band 3 are supplied in a matt finish, the framed mirrors will be supplied in a gloss finish to match the doors. However the framed mirrors for Castana and Pescara, Band 3, will be supplied in a matt finish to match the cabinet.

700 FRAMED MIRROR

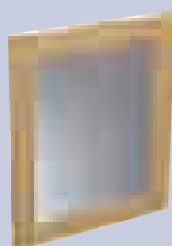

UNIT DIMENSIONS:
700 W x 18 D x 800 H

PRICE BAND	1	2	3	4	5	6
700mm 70TMF White	£135	£135				
700mm 70TMF Timber	£150	£150	£150		£150	
700mm 70TMF White Gloss			£220	£220		£220

The above framed mirrors have been carefully selected to co-ordinate with the cabinet finish. Please note that although the cabinets for Lucia, Modena and Sienna in Band 3 are supplied in a matt finish, the framed mirrors will be supplied in a gloss finish to match the doors. However the framed mirrors for Castana and Pescara, Band 3, will be supplied in a matt finish to match the cabinet.

175 BACKBOARD WITH OPEN GLASS SHELVES



UNIT DIMENSIONS:
175 W x 18 D x 800 H
(125 D including shelves)

PRICE BAND	1	2	3	4	5	6
175mm 175TGS White	£88	£88				
175mm 175TGS Timber	£93	£93	£93		£93	
175mm 175TGS White Gloss			£108	£108		£108

The above backboards with open glass shelves have been carefully selected to co-ordinate with the cabinet finish. Please note that although the cabinets for Lucia, Modena and Sienna in Band 3 are supplied in a matt finish, the backboards will be supplied in a gloss finish to match the doors. However the backboards for Castana and Pescara, Band 3, will be supplied in a matt finish to match the cabinet.

Sizes shown are overall dimensions in mm. All prices include VAT.

MIRROR BACKBOARDS
SUPPLIED ON TITANIUM
EFFECT M.F.C.



UNIT DIMENSIONS:
20 D x 800 H

PRICE BAND	1	2	3	4	5	6
500mm 50TMB	£94	£94	£94	£94	£94	£94
600mm 60TMB	£96	£96	£96	£96	£96	£96
700mm 70TMB	£98	£98	£98	£98	£98	£98

SHELVED MIRROR
BACKBOARD
SUPPLIED ON TITANIUM
EFFECT M.F.C.



UNIT DIMENSIONS:
175 W x 20 D x 800 H
(125 D including shelves).

PRICE BAND	1	2	3	4	5	6
175mm 175TMS	£115	£115	£115	£115	£115	£115

The above shelved mirror backboard is supplied with three glass shelves and fittings.

ILLUMINATED MIRRORS
WITH MOTION SENSOR
IP44 RATING.



UNIT DIMENSIONS:
60 D x 700 H

PRICE BAND	1	2	3	4	5	6
600mm IM60	£210	£210	£210	£210	£210	£210
700mm IM70	£235	£235	£235	£235	£235	£235
800mm IM80	£250	£250	£250	£250	£250	£250
900mm IM90	£265	£265	£265	£265	£265	£265

Illumination by integral lights. Operated by motion sensor sited in the lower right hand side of the mirror housing. Mains 220 - 240v. Illuminated mirrors not to be used in conjunction with other wall units or mirror products. Clearance of at least 150mm required to the right hand side.

CE EN 60598-1:2004+A1:2006, EN60598-21:1989.

Sizes shown are overall dimensions in mm. All prices include VAT.

BATH FRONT PANEL



DIMENSIONS:
1800 L x 450 H (up to 550mm maximum height including adjustable plinth).

PRICE BAND	1	2	3	4	5	6
Bath Front Panel BFP	£134	£146	£158	£162		

When reduced for 1700 baths, panel design will be symmetrical, where appropriate, please refer to technical specification.

BATH FRONT PANEL

DIMENSIONS:
1700 L x 450 H (up to 550mm maximum height including adjustable plinth).

PRICE BAND	1	2	3	4	5	6
Bath Front Panel BP					£194	£198

OFFSET BATH FRONT PANEL



DIMENSIONS:
1800 L x 450 H (up to 550mm maximum height including adjustable plinth).

PRICE BAND	1	2	3	4	5	6
Offset Bath Front Panel BOFP		£146				

Please refer to technical specification.

BATH END PANEL



DIMENSIONS:
800 W x 450 H (up to 550mm maximum height including adjustable plinth).

PRICE BAND	1	2	3	4	5	6
Bath End Panel BEP	£82	£88	£77	£80		

When reduced for 700 wide baths, end panel design will be symmetrical, where appropriate, please refer to technical specification.

BATH END PANEL

DIMENSIONS:
800 W x 450 H (up to 550mm maximum height including adjustable plinth).

PRICE BAND	1	2	3	4	5	6
Bath End Panel EP					£91	£94

BATH BULKHEAD



DIMENSIONS:
900 W x 850 H including one return side.

PRICE BAND	1	2	3	4	5	6
Bath Bulkhead BBH	£152	£152	£171	£180	£191	£200

Plain design with edge profile only.

Sizes shown are overall dimensions in mm. All prices include VAT.

TOILET SEAT



PRICE BAND	1	2	3	4	5	6
Toilet Seat (Chrome Fittings) TSC	£81	£81	£81		£81	

This seat is suitable for Cadiz and Malmo WC's. COMPATIBILITY should be checked at point of purchase.

CABINET PLINTHS



PRICE BAND	1	2	3	4	5	6
1300mm x 180mm 13PS	£30	£30	£30	£43	£30	£43
2000mm x 180mm 20PS	£34	£34	£34	£58	£34	£58
2500mm x 180mm 25PS	£40	£40	£40	£72	£40	£72

Gloss White Cabinet Plinth

1300mm to match Modena and Lucia 13PS			£43			
2000mm to match Modena and Lucia 20PS			£58			
2500mm to match Modena and Lucia 25PS			£72			

Continuous cabinet plinth complete with sealing strip. Cabinet plinths match the cabinet colour.

GLOSS TOILET PLINTH INFIL



Gloss Toilet Plinth infil TPI			£44			
---------------------------------	--	--	-----	--	--	--

Gloss white toilet plinth infil for Modena and Lucia back to wall WC's, for use with 13PS, 20PS and 25PS.

PACK OF 5 ADDITIONAL CABINET LEGS



PRICE BAND	1	2	3	4	5	6
Pack of 5 Additional Cabinet Legs LP	£21	£21	£21	£21	£21	£21

Legs adjustable from 155mm to 195mm.

FITTERS PANEL & TILE INFIL PANELS

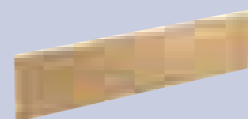

PRICE BAND	1	2	3	4	5	6
Fitters Panel FP20 (2000mm L)	£44	£44	£44	£44*	£44	£44*
Fitters Panel FP27 (2500mm L)	£54	£54	£54	£54*	£54	£54*

340mm high fitters panel supplied to cabinet interior. Grain runs lengthways where applicable.

*This item will be supplied in Matt white finish to match the cabinet interior. Gloss white not available



Tile infil Panels TIP	£17	£17	£17	£20	£17	£20
-------------------------	-----	-----	-----	-----	-----	-----

Two pieces at 850 H x 45 W supplied to cabinet exterior.

ALUMINIUM PLINTH



PRICE BAND	1	2	3	4	5	6
Aluminium Plinth (2000mm x 180mm) 20AP	£77	£77	£77	£77	£77	£77

Continuous plain aluminium faced plinth with 2 internal / external multi-corners and 10 dedicated plinth clips. Aluminium plinth is not suitable for use with Plinthead toilet units.

Sizes shown are overall dimensions in mm. All prices include VAT.

PAVIA

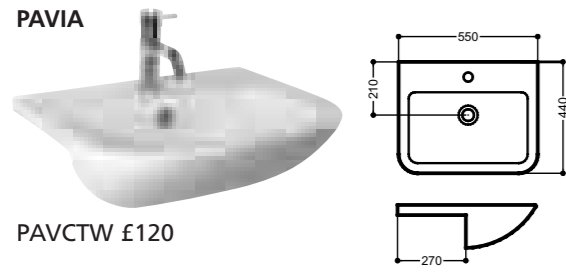

PAVCTW £120

PAVIA BTW WC

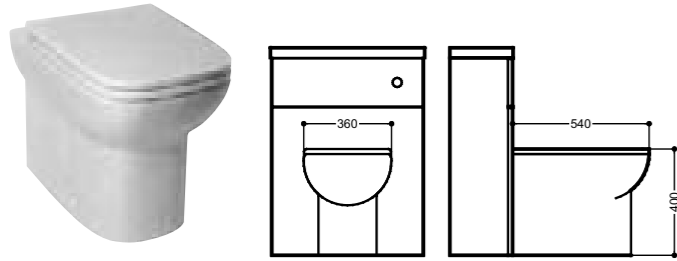

PAVW/WC £125

PAVIA SUSPENDED WC

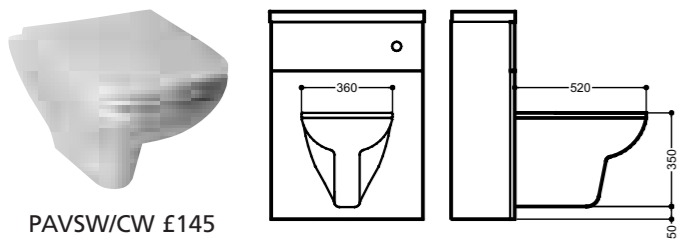

PAVSW/CW £145

PAVIA SEAT

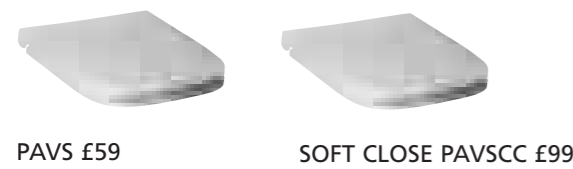

PAVS £59

SOFT CLOSE PAVSCC £99

FORINO

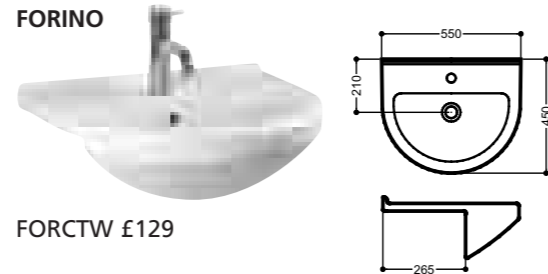

FORCTW £129

FORINO SLIMLINE RH TAP ONLY

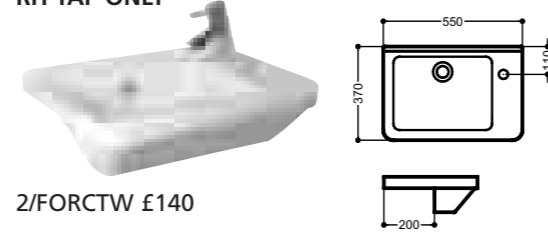

2/FORCTW £140

FORINO BTW WC

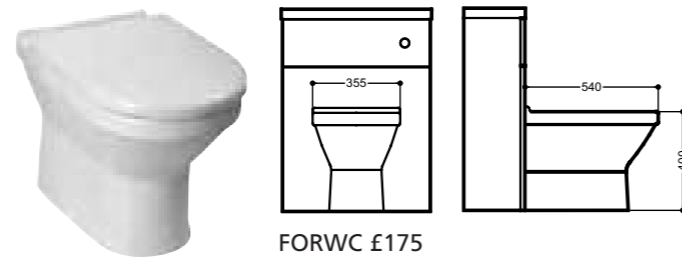

FORWC £175

FORINO SUSPENDED WC

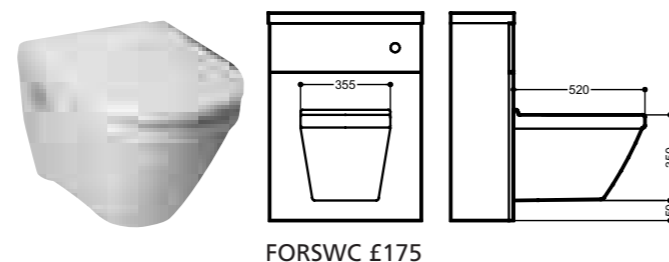

FORSWC £175

FORINO CLOSE COUPLED WC



FORCCWC £310

FORINO SEAT



FORS £67

SOFT CLOSE FORSCC £99

VISTA

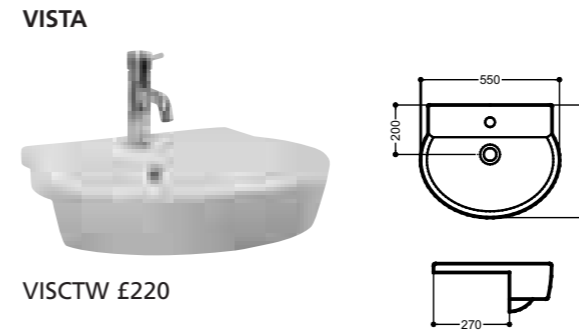

VISCTW £220

VISTA ROUND 45

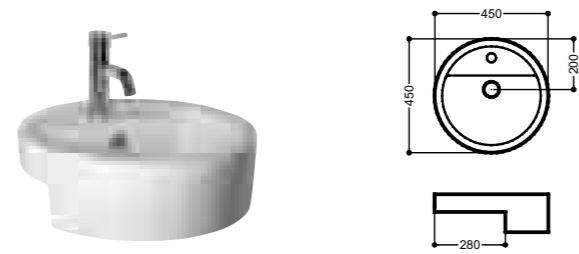

VISRCTW £250

VISTA BTW WC



VISWC £230

VISTA SUSPENDED WC



VISSWC £260

VISTA SLIMLINE 250 LEFT HAND

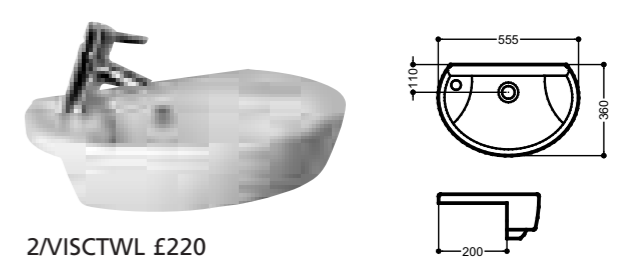

2/VISCTWL £220

VISTA SLIMLINE 250 RIGHT HAND

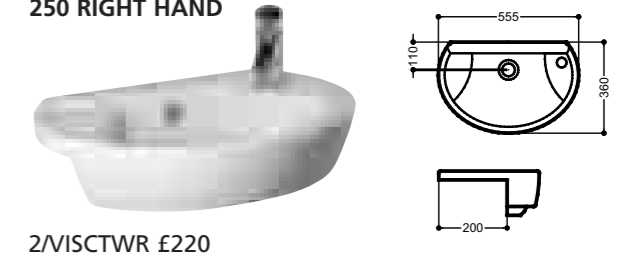

2/VISCTWR £220

VISTA SEAT



VISS £80

SOFT CLOSE VISSCC £125



CADIZ

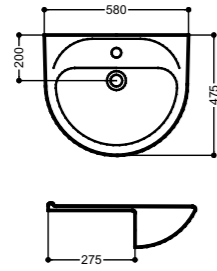

CADCTW £124

CADIZ SLIMLINE 250

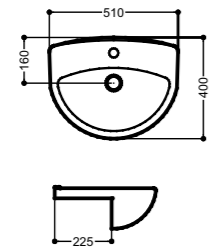

2/CADCTW £150

CADIZ BTW WC

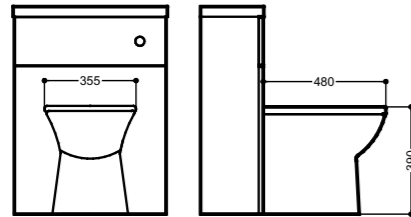

CADW/CW £139

CADIZ SUSPENDED WC

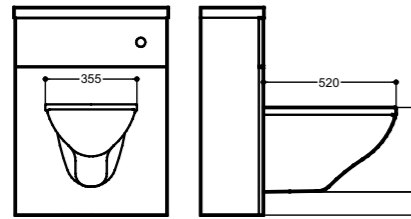
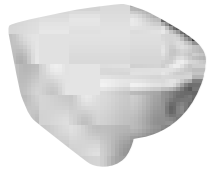

CADSW/CW £139

CADIZ SEAT



CMS £42

SOFT CLOSE SC/CMS £87

MALMO

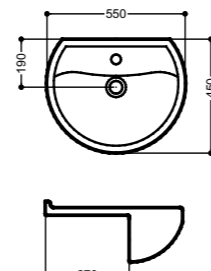

MALCTW £180

MALMO SLIMLINE 250

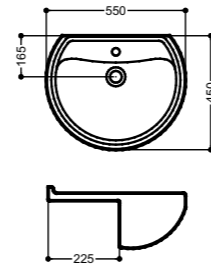

2/MALCTW £180

MALMO BTW WC

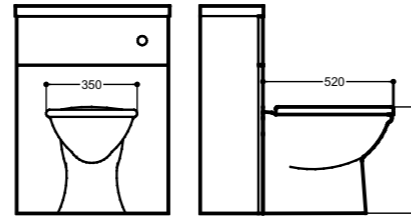

MALW/CW £190

MALMO SEAT



CMS £42

SOFT CLOSE SC/CMS £87



BREEZE 510 SIT ON BASIN



Cast Mineral Basin in White High Gloss BSB510 £330

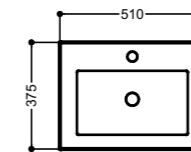

BREEZE 610 SIT ON BASIN



Cast Mineral Basin in White High Gloss BSB610 £340

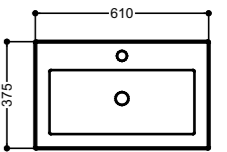

BREEZE 710 SIT ON BASIN

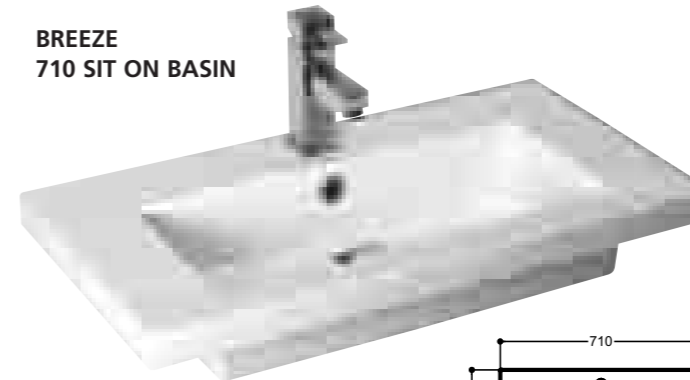

Cast Mineral Basin in White High Gloss BSB710 £350

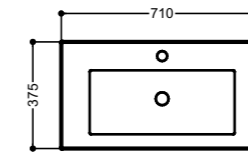

BREEZE 510 SLIMLINE SIT ON BASIN



Cast Mineral Basin in White High Gloss 2/BSB510 £280

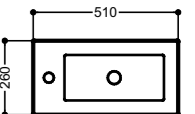

BREEZE SEAT



BRES £91

SOFT CLOSE BRESCC £177

BREEZE BTW WC



BREWC £354

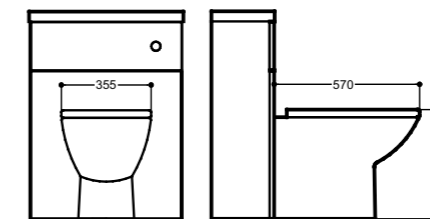

brassware

AZUVI 0.1 Bar unless otherwise stated

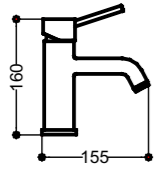
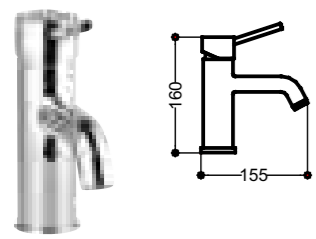

AMBM £99

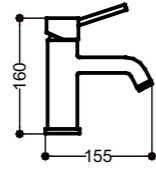
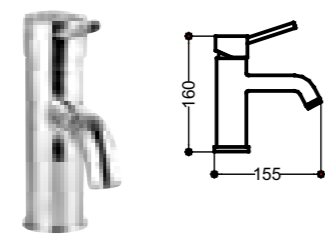

AMBM/NP £95

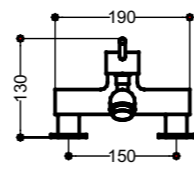
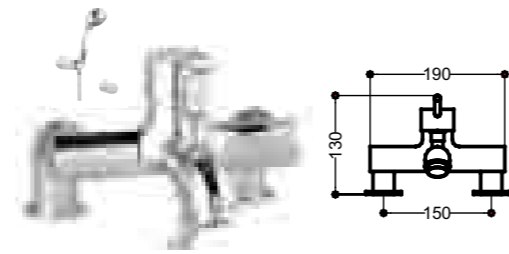

ABSM/E 0.3 Bar £195

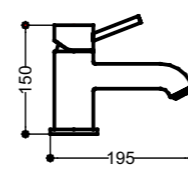
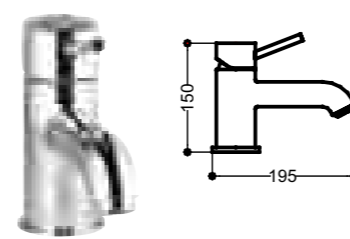

AMBF £109

TESSE 0.2 Bar unless otherwise stated

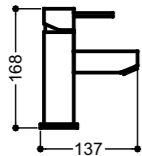

TMBM/NP £150

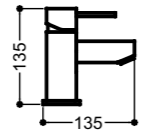

TMMBM/NP £145

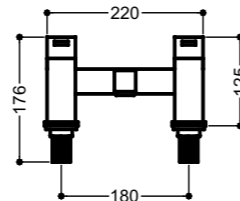

TBF 0.5 Bar £255



MANARA 0.1 Bar

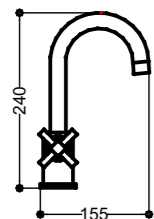

MMBM/NP £165

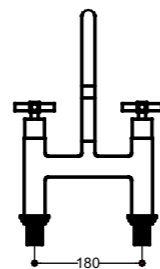

MBF £215

SOLARO 0.1 Bar

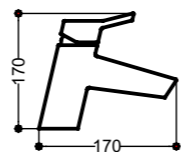

SMBM/NP £108

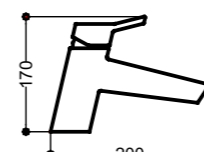

SMBF £160

CLICKER WASTES AND BOTTLE TRAPS

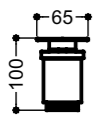

ROUND

RBW £46

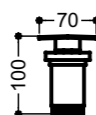

SQUARE

SBW £46

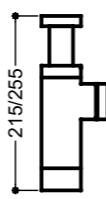
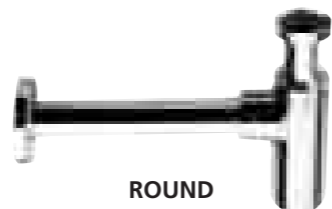

ROUND

RBT £64

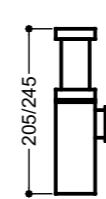
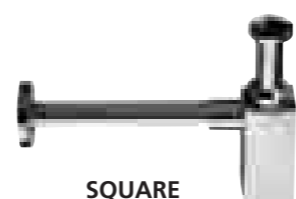

SQUARE

SBT £64

lighting and accessories

MAINS & LOW VOLTAGE APPLICATIONS



2 x 20W Low-Voltage Lights and transformer (chrome) IP20

LVKC £52



2 x 20W Low-Voltage Lights and transformer (chrome) IP65

GLVS £82



Top Fix Picture Light Mains IP44

PLTF £75



Back Fix Picture Light Mains IP44

PLBF £75

CARRIAGE SYSTEMS 365 DEPTH



180 H X 340 W X 330 D with +10 adjustment

CS35 £114



180 H X 690 W X 330 D with +10 adjustment

CS70 £130



180 H X 1040 W X 330 D with +10 adjustment

CS105 £148



180 H X 1390 W X 330 D with +10 adjustment

CS140 £168

ACCESSORIES



CABINET LEGS 180 H with +10 adjustment (set of 4)

ALP4 £75



TOWEL ARM 325 D X 90 W extends to 475mm

Note: not suitable for SLIMLINE furniture (250 depth).

CPTR £48



PAIR OF HINGES

PK2H £9



Pair of soft close door fittings (mirrored cabinets)

PK2SC £9

handle collection

Handles are not supplied with doors

Please select your preferred handle from the selection shown

Prices are for packs of two

Bar handles are supplied individually



CHROME MATRIX
H13 £9



CHROME SQUARE BEVELLED
H16 £10



CHROME KNOB
H22 £10



CHROME
H23 £10



CHROME 'T'
H34 £19



CHROME TRADITIONAL KNOB
H26 £10



CHROME KNOB
H29 £12



CHROME CONICAL
H32 £15



CHROME SCULPTURED SQUARE
H39 £11

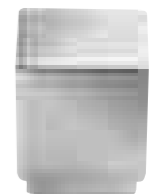

CHROME CUBE
H38 £15



CHROME OBLONG 'T'
H35 £19



CHROME 'T' GROOVED
H40 £15



CHROME 'D' GROOVED
H41 £24

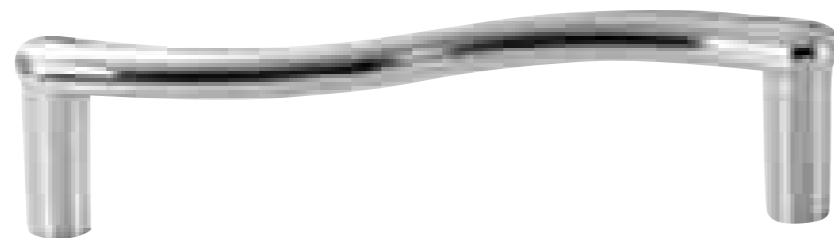

CHROME SLALOM 'D'
H18 £10

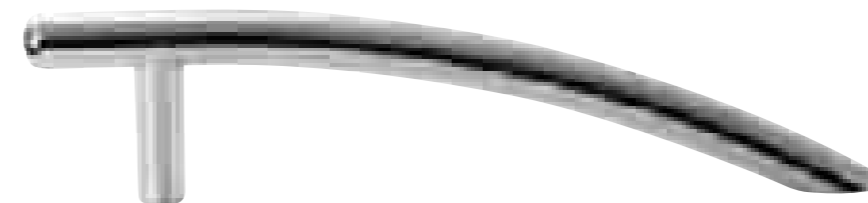

CHROME TAPERED 'D'
H15 £10



CHROME SHAKER 'D'
H17 £10



CHROME MATRIX 'D'
H14 £10

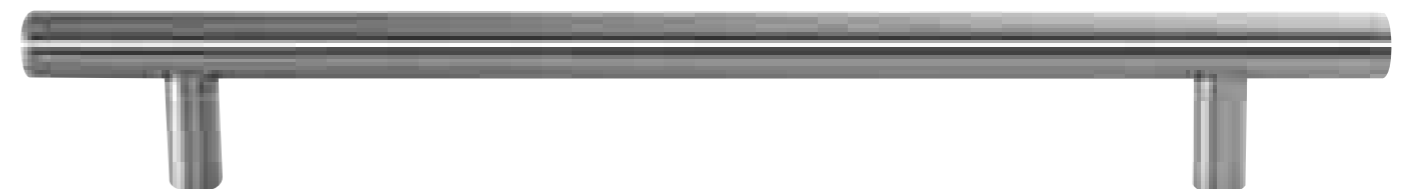

BAR HANDLES (SINGLE)
156mm BH1 £9 | 244mm BH2 £10 | 394mm BH3 £12 | 494mm BH4 £13 | 655mm BH5 £18

Laminate counter tops shelving

GLOSS

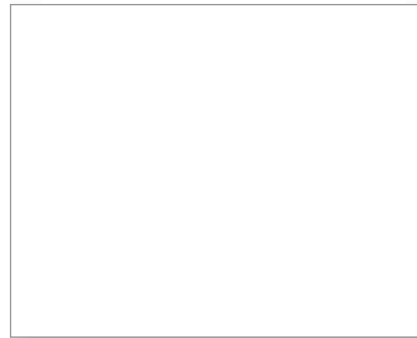

WHITE

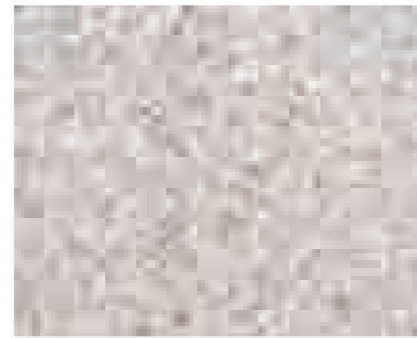

MILLSTONE

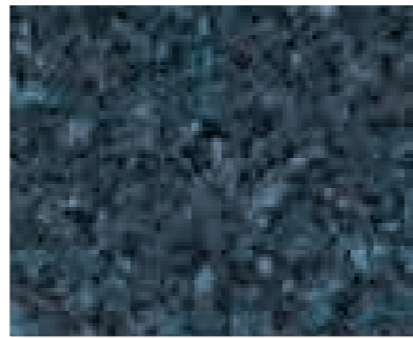

BLUE QUARTZ



SAND



TUSCAN

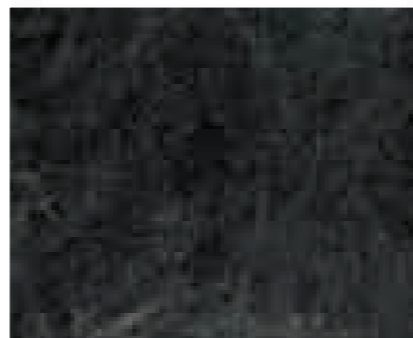

SLATE

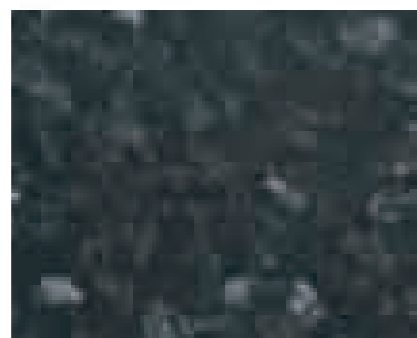

BLACKSTONE



BUTTERUM

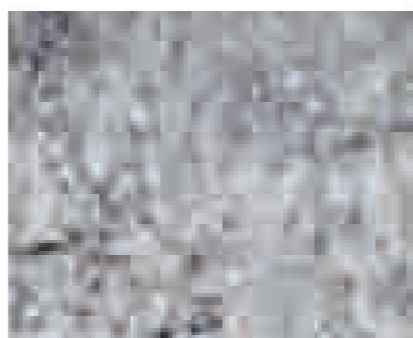

ARRON



SAHARA MICA

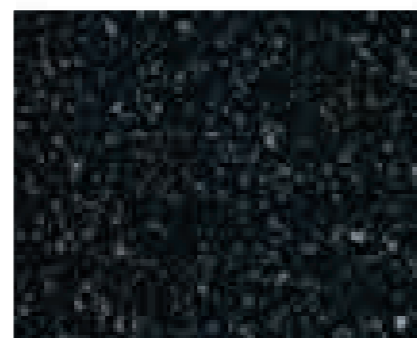

COSMIC MICA



ARTIC MICA



COUNTER TOPS / SHELVING 365mm DEPTH



LENGTH	NON GLOSS	GLOSS
365mm Depth x 30mm Thick		

100CT 1000mm	£63	£72
Supplied finished, with two edging strips		

150CT 1500mm	£89	£104
Supplied finished, with two edging strips		

200CT 2000mm	£115	£131
Supplied finished, with four edging strips		

300CT 3000mm	£150	£177
Supplied unfinished, with four edging strips		

CTPT365
PER 100mm LENGTH **£8** **£9**
Up to 3000mm supplied cut and finished to order requirements

B/S BUTT AND SCRIBE JOINT **£37**
(MASONS MITRE)
Detailed drawing will be required

COUNTER TOPS / SHELVING 250mm DEPTH



LENGTH	NON GLOSS	GLOSS
250mm Depth X 30mm Thick		

SL100CT 1000mm	£63	£72
Supplied finished, with two edging strips		

SL150CT 1500mm	£89	£104
Supplied finished, with two edging strips		

SL200CT 2000mm	£115	£131
Supplied finished, with four edging strips		

CTPT250 **£8** **£9**
PER 100mm LENGTH
Up to 3000mm supplied cut and finished to order requirements.

B/S BUTT AND SCRIBE JOINT **£37**
(MASONS MITRE)
Detailed drawing will be required

SB SHELF BRACKET **£57 (pair)**
Load Capacity 25kg for 275mm depth.
Not suitable for deep tops or shelves.

NON GLOSS

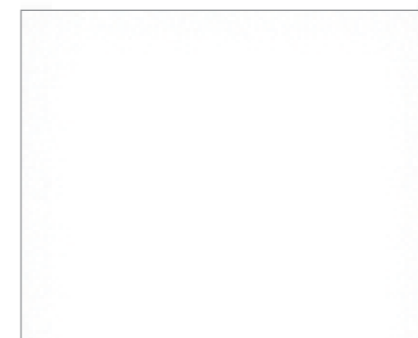

WHITE

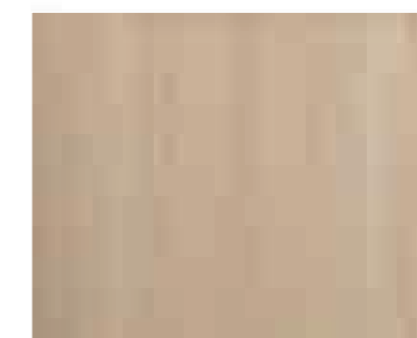

FERRARA OAK

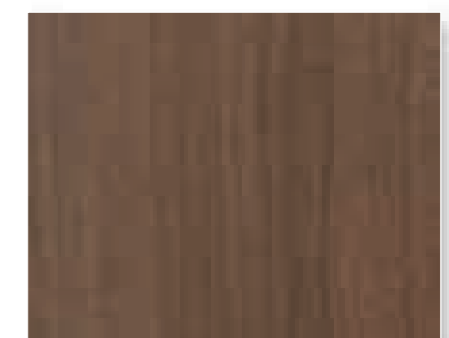

WALNUT



ROMANO CHERRY



NATURAL WALNUT

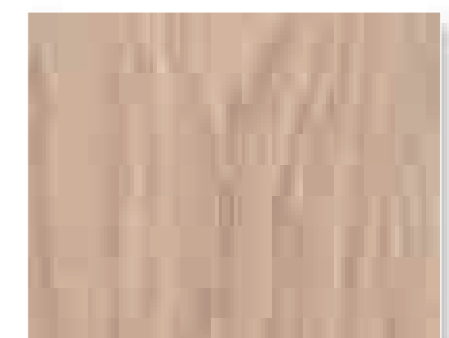

ODESSA OAK

solid surface counter tops and shelving

BAND 1

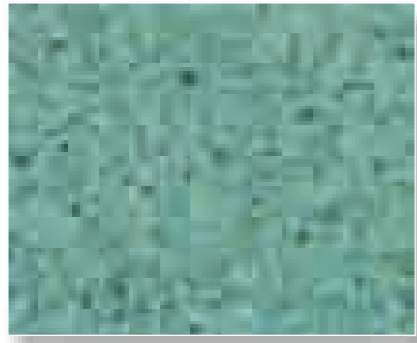

HARRICANA



KARST

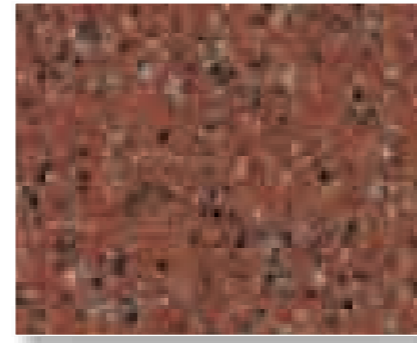

SAHRI

BAND 2



CRYSTAL

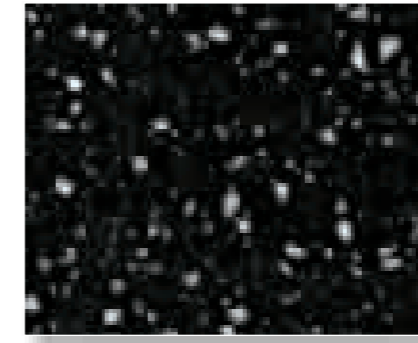

NOVA

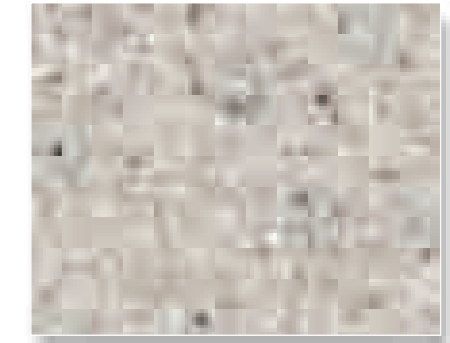

MIRAGE



The modern surface, like all things today needs to be multi functional, this is why solid surface countertops and shelving are such a popular and practical choice.

Solid surface countertops and shelving are produced from a homogeneous acrylic bound material containing natural mineral fillers and high grade engineered resins directly coated to an environmentally friendly core board and balanced with a non-porous material.

Solid surface countertops and shelves provide perfectly smooth and tactile surfaces which allow inconspicuous jointing and edging. Seams are fused together to provide a flush and moisture resistant bond across the surfaces. Since it is non porous, every day stains can be removed with just soap and water.

Band 1 Band 2

P10M 100 x 365 x 30	£23	£26
P10MS 100 x 250 x 30	£19	£23
MCK Customer Care Kit	£32	£32
SB Shelf Bracket	£57	£57

Counter tops & shelving will be supplied with a Customer Care Kit at an additional cost of £32

Example

1435mm x 365mm Counter Top
15 rounded up to nearest 100mm

Band 1 Band 2

P10M x 15	£345	£390
MCK x 1	£32	£32

Total Cost **£377 £422**

Order acceptance of cut service counter tops and shelving must be confirmed by a signed drawing if required. Under no circumstances can alterations, cancellations or returns be accepted.

corian bespoke counter tops

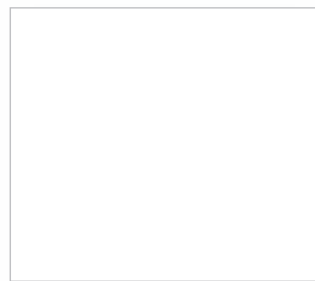

GLACIER WHITE - BASIN COLOUR

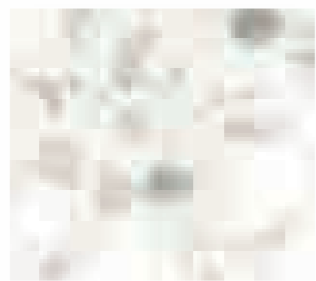

SILVER BIRCH

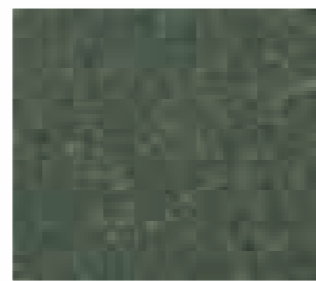

AUTUMN LEAVES



BLACK QUARTZ

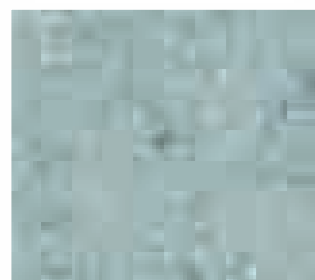

AQUA

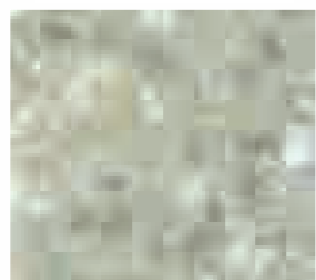

CARRIBEAN



EVEREST

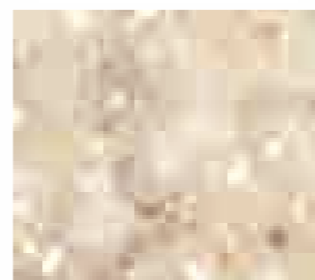

SAHARA



ATLANTIS

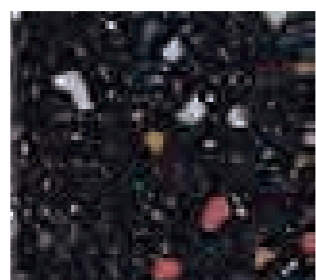

MARDI GRAS

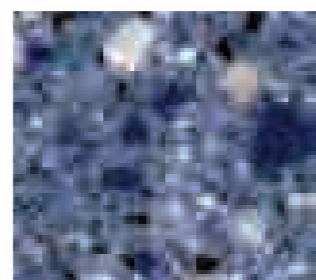

MEDITERRANEAN

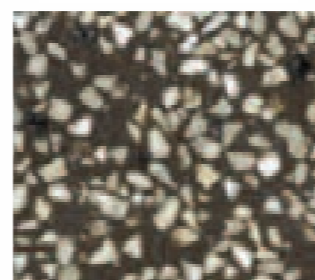

PALLADIAN BROWN

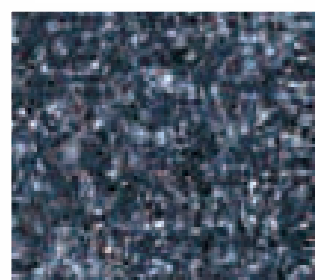

OCEANIC



WHITE CAP

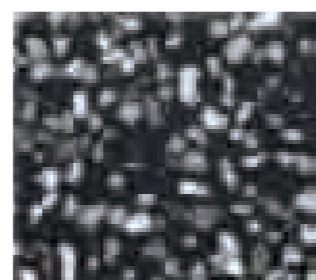

PALLADIAN BLACK

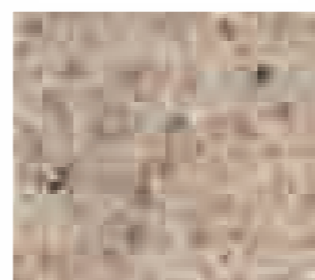

SANDSTONE

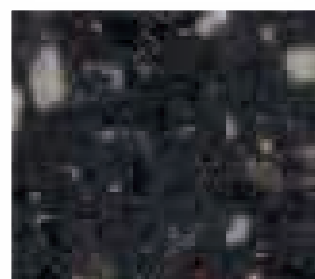

GRAVEL

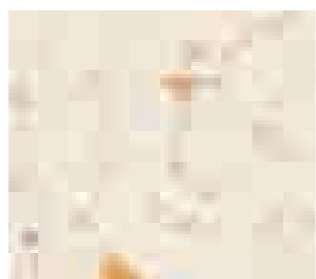

TUMBLLED GLASS

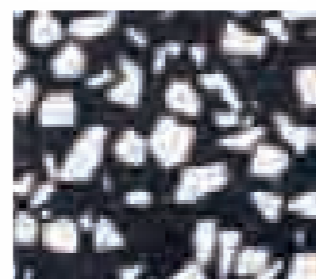

WHITE CHIP



BLACK CHIP

BOWLS AND COWLS

SIZE



620 x 510 620mm Top
C.620 £823

720 x 510 720mm Top
C.720 £833

The above items include the top, bowl, front cowl and two finished ends.

COUNTER TOPS



per 100mm L x 365 D
C.100 £33



per 100mm L x 250 D
RC.100 £32

This item is not compatible with bowl options

ACCESSORIES



500 x 150 CISTERN INSPECTION COVER
CCC £89



Charge for finished end
C.RE £57

Corner fixing kit
CFK £11

Please indicate dimensions below when ordering. Always start with the basic top size i.e. Dimension A. Please state all dimensions in millimetres and give relevant centres for bowls and cistern covers. For tap holes please state positions and diameters of holes. A distance of 50mm is recommended from the back edge of top (please allow for any tiles etc.)

Corian® tops are of a bespoke nature and manufactured to customers specifications.

Sizes shown are overall dimensions in mm. All prices include VAT.



Length A =1295mm
Length B =1645mm
Width C = 365mm
Length D = 720mm
Total Length =1855mm
Divided by 100 =18.55 (Round up to nearest whole number)
Additional lengths =19



Retail Price of this example inc. VAT £1560

Price: 'L' Shaped installation
Example based on CORIAN® Price Band 2

C.720	720mm Top	Price	1 x	£833	£833
C.100	Additional lengths per 100mm	Price	19 x	£33	£627
CCC	Cistern Cover	Price	1 x	£89	£89
CFK	Corner Fixing Kit	Price	1 x	£11	£11

Sizes shown are overall dimensions in mm. All prices include VAT.

Please feel free to use the guides given to enable you to formulate the cost of your countertop. We will require a detailed drawing covering all dimensions and walls where applicable to ensure accurate costs. The drawing must also indicate any finished edge or in some cases where the countertop may be placed to adjacent furniture.

On receipt of this information a detailed drawing indicating full specifications and costs will be relayed back to your approved dealer. This should be checked thoroughly, signed and returned to enable production of this item.

It is not possible to alter any information once the item has been processed. We will not agree to any cancellation, alteration or restocking, as these items are made to customers requirements. These items will remain chargeable.

Corian® is a DuPont registered trademark - only DuPont makes Corian®

dimensions

BATH FRONT AND END PANELS

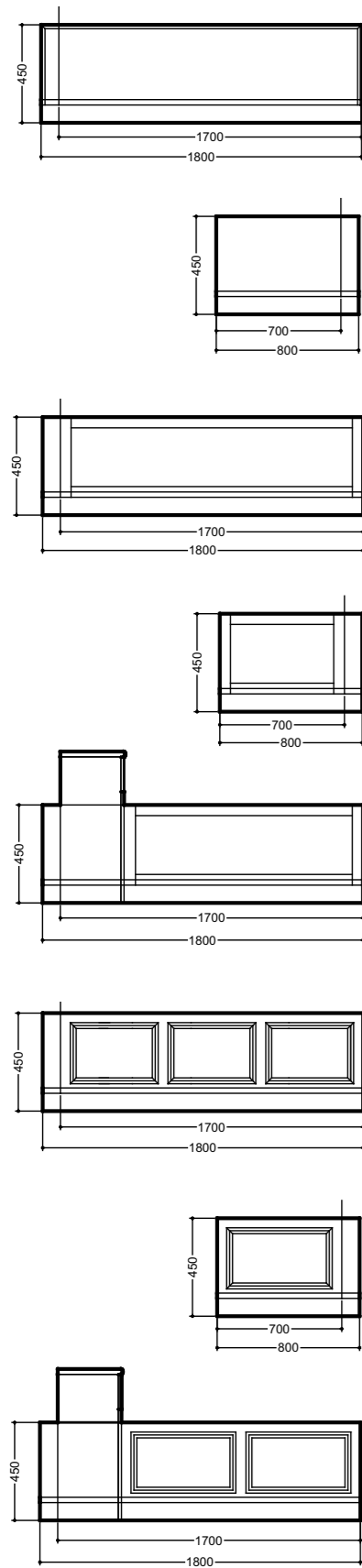

FULL PANEL DESIGN FOR FLOORSTANDING AND SUSPENDED BACK TO WALL TOILETS

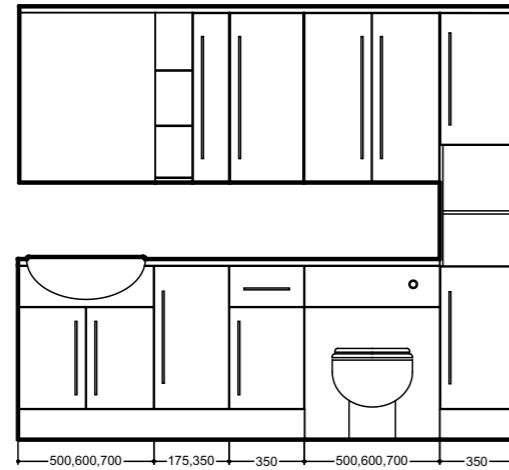

CONTINUOUS PLINTH FOR USE WITH FLOORSTANDING 'BACK TO WALL' TOILETS

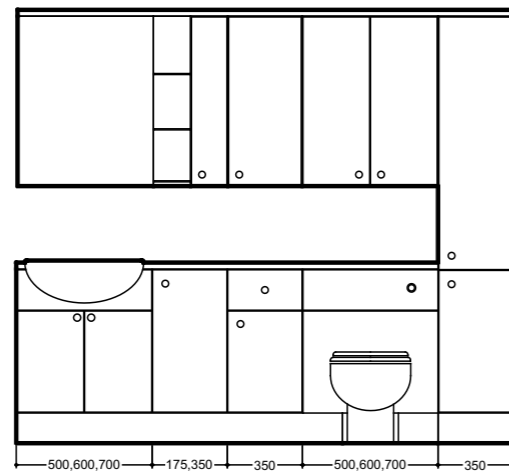

RECOMMENDED BAR HANDLES

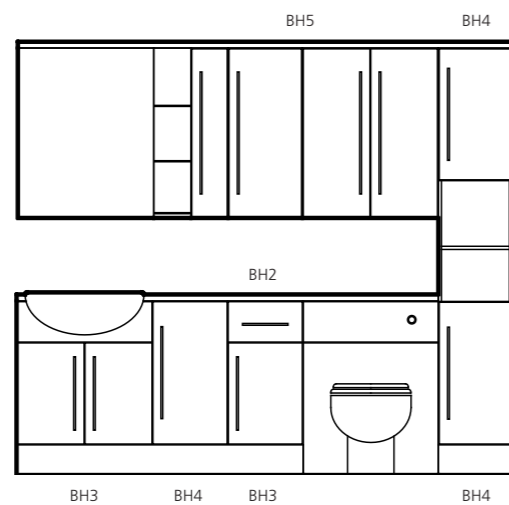

STANDARD 365

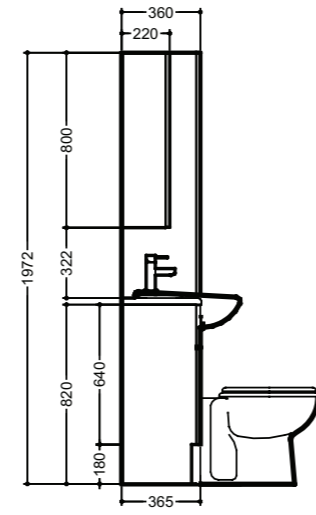

STANDARD / BREEZE 365

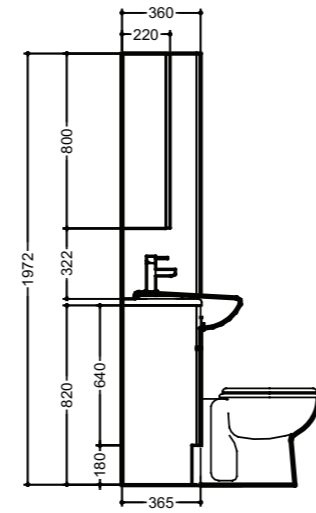

SLIMLINE 250

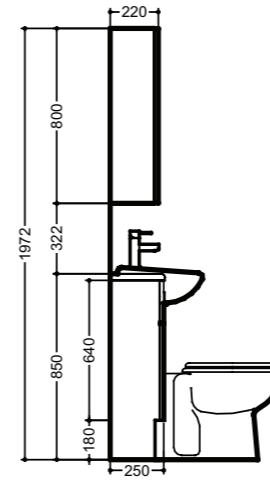

BREEZE 365

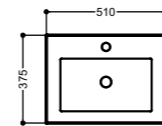
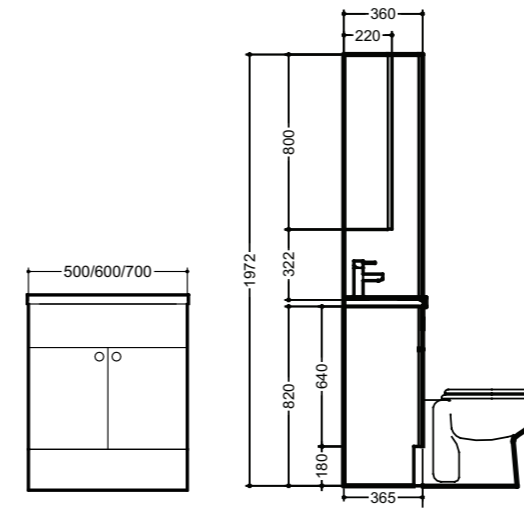

BREEZE 510

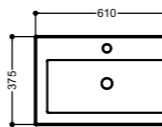

BREEZE 610

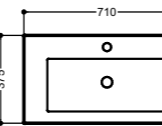

BREEZE 710

price examples

1200mm Base installation

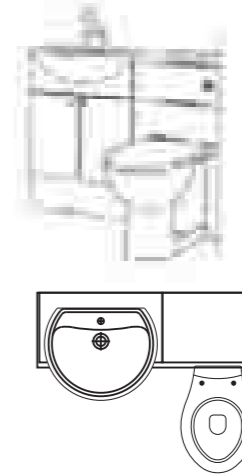

Band 1	£727
Band 2	£765
Band 3	£843
Band 4	£900
Band 5	£878
Band 6	£937

Pricing contents:
R/70BCB, R/FP50WC, 150CT, 13PS, H--

1200mm Base and wall installation

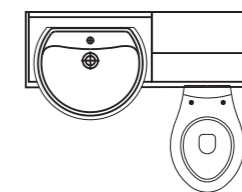
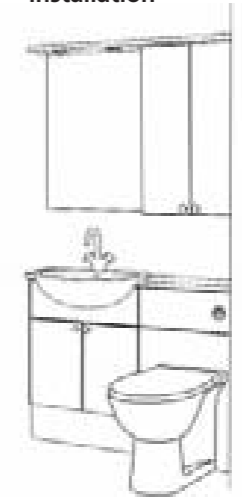

Band 1	£1141
Band 2	£1198
Band 3	£1316
Band 4	£1400
Band 5	£1357
Band 6	£1440

Pricing contents:
R/70BCB, R/FP50WC, 150CT, 13PS, R/50TW, 70TMB, SL150CT, H--

1375mm Base installation

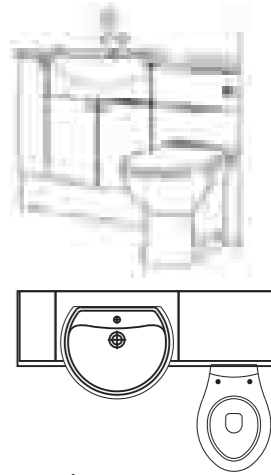

Band 1	£876
Band 2	£921
Band 3	£1012
Band 4	£1092
Band 5	£1054
Band 6	£1135

Pricing contents:
R/70BCB, R/FP50WC, R/175BSD, 150CT, 20PS, H--

1375mm Base and wall installation

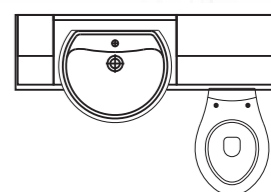
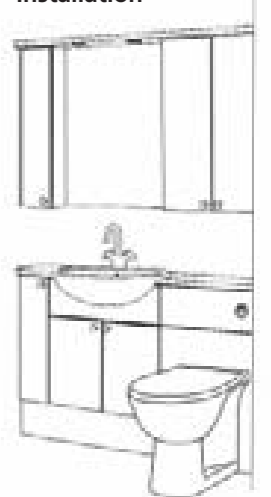

Band 1	£1432
Band 2	£1504
Band 3	£1649
Band 4	£1766
Band 5	£1701
Band 6	£1817

Pricing contents:
R/70BCB, R/FP50WC, R/175BSD, 150CT, R/50TW, 70TMB, R/175TW, SL150CT, 20PS, H--

Prices are based on furniture only, sanitaryware and associated products are not included. All prices include VAT.

FSC® CHAIN OF CUSTODY CERTIFICATION

Be Modern hold full Forestry Stewardship Council chain of custody certification, your guarantee that all timber products used in our furniture come from well managed sources and comply with environmental, social and economic standards

By choosing FSC products you can avoid buying wood from destructive forestry and can help to ensure forests are protected for the long-term while remaining commercially-viable.

- ■ ■ FSC labelled products are made with consideration for people, wildlife and the environment.
- ■ ■ The FSC label guarantees that the trees that are harvested are replaced or are allowed to regenerate naturally and parts of the forest are protected entirely, in order to protect rare animals and plants.
- ■ ■ FSC protects the rights of indigenous people to use the forest. Sacred sites in the forest are exempt from felling.
- ■ ■ FSC is the only wood certification scheme endorsed by the major environmental charities, including WWF, Friends of the Earth, Greenpeace and the Woodland Trust.



The mark of responsible forestry

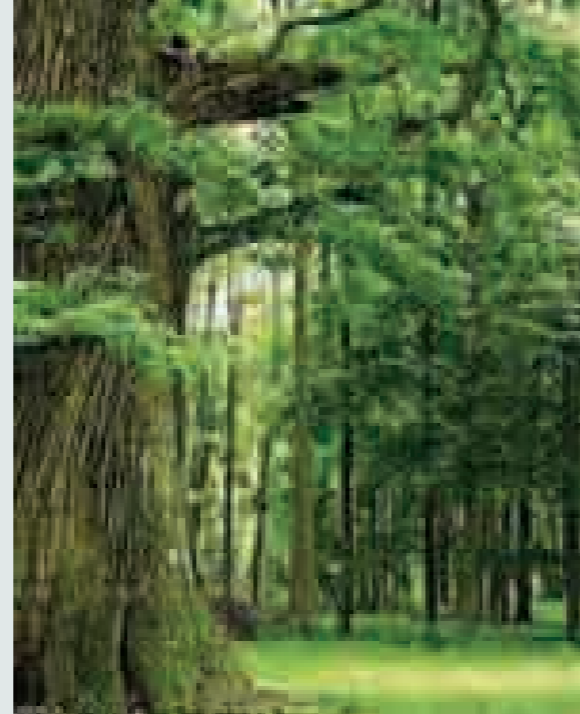

OUR COMMITMENT TO QUALITY AND THE ENVIRONMENT

The reputation of the organisation rests on the high quality of our products hence all products are inspected throughout the production process.

Our quality management system is certified to ISO:9001:2008 and covers all areas of the business from manufacturing to customer service

Be Modern produce bathroom furniture in its own factory in the North East of England. Methods are in place to reduce waste and increase energy efficiency throughout the plant.

Our environmental management system is certified to ISO14001:2004 standards outlining our commitment to continually improve our environmental performance

Our commitment to minimise our environmental impact includes continual capital expenditure on state of the art machinery to improve efficiency and quality.

We welcome feedback on all aspects of our business, if you have any comments you can e-mail us at enquiries@atlantabathrooms.com



ATLANTA: CONDITIONS

INSTALLATION Atlanta bathroom furniture is designed for domestic use in well ventilated areas fitted with a suitable extractor fan. Products should be installed and cared for in accordance with our fitting and care instructions.

Wall mounted units are supplied with substantial mounting brackets. The installer must provide suitable wall fixings dependent on the type and condition of the wall. A secondary fix will be required on the unit by the installer.

It is important that a waterproof sealant is used on cut or raw edges and particular attention should be given to areas around the basin and bath.

ELECTRICAL INSTALLATIONS Electrical connections should always be carried out by a qualified electrician. Lights and illuminated mirrors are IP rated to ensure they are fitted in the correct zone.

Care should be taken to avoid shower spray or splashing. Electrical appliances connected to mirror cabinets should not be operated whilst bathing or showering.

CORIAN®

Corian® Solid surfacing is supplied on a bespoke service, which incorporates a specially developed cowl. When ordering Corian your retailer will need to supply an accurate drawing. Once ordered it may not be possible to amend dimensions and your order will be chargeable.

SPECIAL SIZES

Because of the bespoke nature of these products we will not restock countertops, open shelf units or shelving that have been specified for individual orders. A restocking charge will be made on all products returned to stock.

ATLANTA: GUARANTEES

GUARANTEE: FURNITURE AND CERAMIC SANITARYWARE A five-year guarantee against manufacturing defects applies to all furniture, fittings and ceramic sanitaryware. The surfaces of ceramic products may contain imperfections. The guarantee is limited to domestic use by the consumer in a well-ventilated area fitted with an extractor fan. The guarantee is offered on all products used in the manner for which they were intended and does not apply to products that have been misused or abused in any way.

The products must have been installed and cared for in accordance with our fitting and care instructions and the appropriate byelaws and regulations. The guarantee does not cover general wear and tear. In the unlikely event that a product fails within the guarantee period we will offer a replacement or replacement parts (or nearest equivalent). Liability is limited to individual products and does not cover consequential loss, damages or further installation costs involved. The guarantee, which applies to the UK only, is limited to the original purchaser and is not transferable. This guarantee does not affect the customers statutory rights.

GUARANTEE: BRASSWARE Brassware is covered by a five-year guarantee against manufacturing defects providing that the product has been installed correctly and the correct plumbing practices have been carried out. Sprung pop-up wastes carry a one-year guarantee. The guarantee does not cover general wear and tear. The shower kit including handset and metal flexible tube carries a one year guarantee.

GUARANTEE: CAST MINERAL WASHBASINS Cast mineral washbasins are covered by a five-year guarantee provided the basin has been correctly installed and cared for in accordance with the Care and Maintenance Guidelines supplied with the product. Cast basins are designed and guaranteed to be used with hot water up to a maximum temperature of 65°C, this temperature must not be exceeded. The use of taps with 'pop-up' wastes is not recommended for Breeze basins.

GUARANTEE: LIGHTS AND ILLUMINATED MIRRORS Electrical fittings and components together with illuminated mirrors are covered by a one-year guarantee provided they have been correctly installed and used for the purposes for which they were intended.

GENERAL Please inspect all products carefully before installation. The guarantee does not cover any subsequent installation costs incurred if faults, which would have been evident at the time of delivery are discovered after installation.

DIMENSIONAL TOLERANCE Due to the nature of materials and production processes dimensions of ceramic items and mineral castings may vary within a tolerance of $\pm 2\%$.

FURNITURE MATERIALS All timber finishes in the Atlanta range are wood effects. Although great care is taken in choosing matching finishes there may be some variation due to the different materials, suppliers, batches and manufacturing processes used.

The apparent colour of finishes may also vary under different lighting conditions, especially artificial light.

ATLANTA: GUIDELINES FOR CARE AND MAINTENANCE

FURNITURE Wipe spills up immediately with a clean cloth. We recommend that the furniture be cleaned with a damp cloth and dried off. Avoid using abrasive cleaners or polishes that contain solvents, acid or ammonia.

CERAMIC SANITARYWARE Clean with a damp cloth and warm soapy water; rinse with clean water and polish with soft cloth. Avoid using abrasive cleaners or polishes that contain solvents, acid or ammonia.

CAST MINERAL WASHBASINS Clean with a damp cloth, water and soap or very mild detergent, rinse and polish with a soft cloth. Avoid using abrasive cleaners or polishes that contain solvents, acid or ammonia.

For a good shine use a fine polish around twice a year and then finish with wax e.g. car wax. Full care instructions are included with the washbasin.

BRASSWARE Clean with a damp cloth, water and soap, rinse clean and polish with a cloth. Avoid using abrasive cleaners or polishes that contain solvents, acid or ammonia.

COLOUR REPRODUCTION Colour reproduction is as accurate as possible within the limitations of the printing process. Please ask for a sample of the actual colour. Also note, colours will vary under artificial light.

The Be Modern Group policy is one of continual improvement and development. We therefore reserve the right to alter materials and specifications without notice.